

EOM
ENGINEERING OPERATION
& MAINTENANCE

H1500

Saniflo™ HS

Clamped Metal Pumps



Where Innovation Flows

WILDEN®

Contents

Section 1: Precautions - Read First!	4
Section 2: Wilden Pump Designation System	5
Section 3: How It Works	6
Section 4: Dimensional Drawings	7
Section 5: Performance	8
H1500 Saniflo HS Full-Stroke TPE Integral Piston Diaphragm-Fitted.....	8
Suction-Lift Curves.....	9
Section 6: Suggested Installation, Operation, Maintenance and Troubleshooting	10
Section 7: Disassembly / Reassembly	13
Pump Disassembly.....	13
Air Valve / Center Section Disassembly.....	17
Power Cylinder Reassembly.....	22
Single-Point Exhaust.....	23
Reassembly Hints & Tips.....	23
Section 8: Clean-In-Place - CIP	25
Section 9: Exploded View and Parts List	26
H1500 Saniflo™ HS.....	26
H1500 Saniflo™ HS 1935/2004/EC.....	28
Section 10: Elastomer Options	30



Copyright

Copyright 2018 PSG®, a Dover Company. All rights reserved.

PSG reserves the right to modify the information and illustrations in this document without prior notice. The product described in this document is furnished under a license agreement or nondisclosure agreement. No part of this document may be reproduced, stored in a retrieval system, or transmitted in any form or any means electronic or mechanical, including photocopying and recording, without the written permission of PSG, a Dover Company, except as described by the terms of those agreements.

This is a non-contractual document. 01-2019.

Trademarks

PSG and the PSG logo are registered trademarks of PSG. Wilden® is a registered trademark of PSG California LLC. Pro-Flo® SHIFT and Pro-Flo® are registered trademarks of PSG California LLC. Wil-Flex® is a trademark of PSG California LLC. Saniflex™ is a trademark of PSG California LLC.

All trademarks, names, logos and service marks (collectively "trademarks") in this document are registered and unregistered trademarks of their respective owners. Nothing contained in this document should be construed as granting any license or right to use any trademark without the prior written permission of the trademark owner.

Warranty

Each and every product manufactured by Wilden is built to meet the highest standards of quality. Every pump is functionally tested to insure integrity of operation. Wilden warrants that pumps, accessories and parts manufactured or supplied by it to be free from defects in material and workmanship for a period of five (5) years from date of installation or six (6) years from date of manufacture, whichever comes first.

For more information, and to register your Wilden pump for warranty, please visit <https://www.psgdover.com/wilden/support/warranty-registration>.

Certifications

**CSI**CONTACT CSI FOR MORE INFORMATION | CSIDESIGNS.COM | SALES@CSIDESIGNS.COM | 417.831.1411

Section 1

Precautions - Read First!

 **CAUTION:** Do not apply compressed air to the exhaust port — pump will not function.

 **CAUTION:** Do not over-lubricate air supply — excess lubrication will reduce pump performance. Pump is pre-lubed.

 **TEMPERATURE LIMITS:**

Polypropylene	0°C to 79°C	32°F to 175°F
PVDF	-12°C to 107°C	10°F to 225°F
PFA	7°C to 107°C	45°F to 225°F
Neoprene	-18°C to 93°C	0°F to 200°F
Buna-N	-12°C to 82°C	10°F to 180°F
EPDM	-51°C to 138°C	-60°F to 280°F
FKM	-40°C to 177°C	-40°F to 350°F
Wil-Flex™	-40°C to 107°C	-40°F to 225°F
Saniflex™	-29°C to 104°C	-20°F to 220°F
Polyurethane	-12°C to 66°C	10°F to 150°F
Polytetrafluoroethylene (PTFE) ¹	4°C to 104°C	40°F to 220°F
Nylon	-18°C to 93°C	0°F to 200°F
Acetal	-29°C to 82°C	-20°F to 180°F
SIPDPTFE with Neoprene-backed	4°C to 104°C	40°F to 220°F
SIPDPTFE with EPDM-backed	4°C to 137°C	40°F to 280°F
Polyethylene	0°C to 70°C	32°F to 158°F
Geolast®	-40°C to 82°C	-40°F to 180°F

¹14°C to 149°C (40°F to 300°F) - 13 mm (1/2") and 25 mm (1") models only.

NOTE: Not all materials are available for all models. Refer to Section 2 for material options for your pump.

 **CAUTION:** When choosing pump materials, be sure to check the temperature limits for all wetted components. Example: FKM has a maximum limit of 177°C (350°F) but polypropylene has a maximum limit of only 79°C (175°F).

 **CAUTION:** Maximum temperature limits are based upon mechanical stress only. Certain chemicals will significantly reduce maximum safe operating temperatures. Consult Chemical Resistance Guide for chemical compatibility and temperature limits.

 **WARNING:** Prevent static sparking. If static sparking occurs, fire or explosion could result. Pump, valves and containers must be grounded to proper grounding point when handling flammable fluids and whenever discharge of static electricity is a hazard.

 **CAUTION:** Do not exceed 5.9 bar (85 psig) air supply pressure.

 **CAUTION:** All piping, valves, gauges and other components installed on the liquid discharge must have a minimum pressure rating of 20.7 bar (300 psig).

 **CAUTION:** The discharge pressure generated by this pump is three times the inlet pressure supplied.

 **CAUTION:** The process fluid and cleaning fluids must be chemically compatible with all wetted pump components. Consult Chemical Resistance Guide.

 **CAUTION:** Pumps should be thoroughly flushed before installing into process lines. FDA- and USDA-approved pumps should be cleaned and/or sanitized before being used.

 **CAUTION:** Always wear safety glasses when operating pump. If diaphragm rupture occurs, material being pumped may be forced out air exhaust.

 **CAUTION:** Before any maintenance or repair is attempted, the compressed air line to the pump should be disconnected and all air pressure allowed to bleed from pump. Disconnect all intake, discharge and air lines. Drain the pump by turning it upside down and allowing any fluid to flow into a suitable container.

 **CAUTION:** Blow out air line for 10 to 20 seconds before attaching to pump to make sure all pipeline debris is clear. Use an in-line air filter. A 5µ (micron) air filter is recommended.

 **NOTE:** Before starting disassembly, mark a line from each liquid chamber to its corresponding air chamber. This line will assist in proper alignment during reassembly.

 **CAUTION:** Wilden® H1500 High Pressure pumps can- not be used in submersible applications.

 **CAUTION:** Tighten all hardware prior to installation.

 **NOTE:** When installing PTFE diaphragms, it is important to tighten outer pistons simultaneously (turning in opposite directions) to ensure tight fit . (See Torque Specifications in Section 7.)

 **CAUTION:** Do not over-lubricate air supply – excess lubrication will reduce pump performance. Pump is pre-lubricated.



Section 2

WILDEN PUMP DESIGNATION SYSTEM

**H1500 SANIFLO™
HYGIENIC SERIES**

**76 mm (3") Pump
Maximum Discharge
Pressure:
17.2 bar (250 psig)**

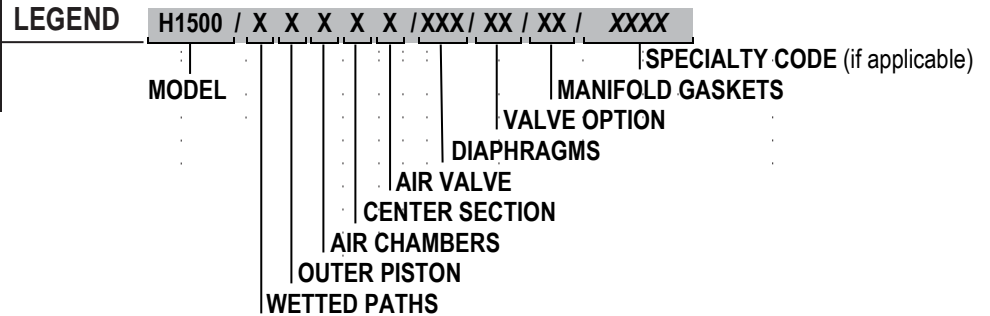

MATERIAL CODES

MODEL
H1500 = HIGH-PRESSURE
SANIFLO HYGIENIC

WETTED PATH
S = STAINLESS STEEL

OUTER PISTON
S = STAINLESS STEEL
Z = NO PISTON

AIR CHAMBER
S = 316 STAINLESS STEEL

CENTER SECTION
I = POWDER-COATED
ALUMINUM

AIR VALVE
I = POWDER-COATED
ALUMINUM

DIAPHRAGMS
FWL = FULL-STROKE SANITARY
WIL-FLEX™ IPD^{1,3}
FWS = SANITARY WIL-FLEX™,
EZ-INSTALL
[SANTOPRENE®
(TWO ORANGE DOTS)]^{1,3}
TSS = FULL-STROKE PTFE
W/SANIFLEX™ BACK-
UP^{1,2,3}
TWS = FULL-STROKE PTFE
WIL-FLEX™ BACKUP
[Santoprene® (Three Black
Dots)]^{1,2,3}

VALVE BALLS/MUSHROOM CHECK
FW = SANITARY WIL-FLEX™
[Santoprene® (Two Orange Dots)]^{1,3}
TF = PTFE (White)^{1,2,3}
TM = PTFE MUSHROOM CHECK^{1,2,3}

MANIFOLD GASKET
FE = SANITARY EPDM^{1,3}
(Green Dot)
FV = SANITARY FKM^{1,3}
(One White/One Yellow Dot)
TF = PTFE (White)^{1,2,3}

NOTES:
¹ Meets Requirements of FDA CFR21.177
² Meets Requirements of USPClass VI
³ Meets Requirements of 1935/2004/EC

SPECIALTY CODES

0770 Saniflo™ HS
0770E Saniflo™ HS (1935/2004/EC)

NOTE: Most Elastomeric materials use colored dots for identification.
NOTE: Not all models are available with all material options.

Hytrel® is a registered trademark of DuPont Dow Elastomers.
Santoprene® is a registered trademark of Monsanto Company, licensed to Advanced Elastomer Systems, L.P.



CSI

CONTACT CSI FOR MORE INFORMATION | CSIDESIGNS.COM | SALES@CSIDESIGNS.COM | 417.831.1411

Section 3

HOW IT WORKS — PUMP

The Wilden diaphragm pump is an air-operated, positive displacement, self-priming pump. These drawings show flow pattern through the pump upon its initial stroke. It is assumed the pump has no fluid in it prior to its initial stroke.

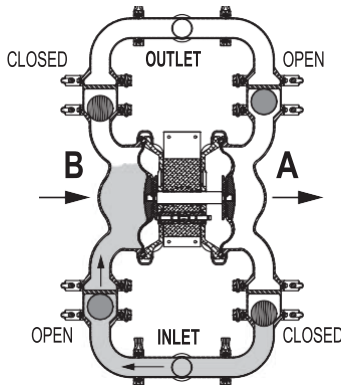

FIGURE 1 The air valve directs pressurized air to the back side of diaphragm A. The compressed air is applied directly to the liquid column separated by elastomeric diaphragms. The diaphragm acts as a separation membrane between the compressed air and liquid; a balanced load removes mechanical stress from the diaphragm. The compressed air moves the diaphragm away from the center of the pump. The opposite diaphragm is pulled in by the shaft connected to the pressurized diaphragm. Diaphragm B is on its suction stroke; air behind the diaphragm has been forced out to atmosphere through the exhaust port of the pump. The movement of diaphragm B toward the center of the pump creates a vacuum within chamber B. Atmospheric pressure forces fluid into the inlet manifold forcing the inlet valve ball off its seat. Liquid is free to move past the inlet valve ball and fill the liquid chamber (see shaded area).

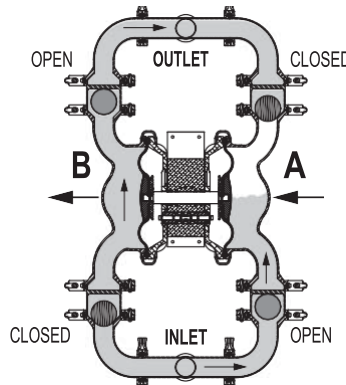

FIGURE 2 When the pressurized diaphragm, diaphragm A, reaches the limit of its discharge stroke, the air valve redirects pressurized air to the back side of diaphragm B. The pressurized air forces diaphragm B away from the center while pulling diaphragm A to the center. Diaphragm B is now on its discharge stroke. Diaphragm B forces the inlet valve ball onto its seat due to the hydraulic forces developed in the liquid chamber and manifold of the pump. These same hydraulic forces lift the discharge valve ball off its seat, while the opposite discharge valve ball is forced onto its seat, forcing fluid to flow through the pump discharge. The movement of diaphragm A toward the center of the pump creates a vacuum within liquid chamber A. Atmospheric pressure forces fluid into the inlet manifold of the pump. The inlet valve ball is forced off its seat allowing the fluid being pumped to fill the liquid chamber.

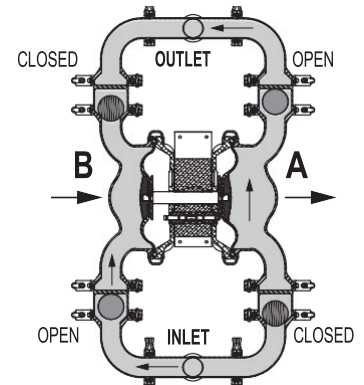

FIGURE 3 At completion of the stroke, the air valve again redirects air to the back side of diaphragm A, which starts diaphragm B on its exhaust stroke. As the pump reaches its original starting point, each diaphragm has gone through one exhaust and one discharge stroke. This constitutes one complete pumping cycle. The pump may take several cycles to completely prime depending on the conditions of the application.

HOW IT WORKS — THE POWER PRINCIPLE

The H1500 HS uses an integral power amplifier piston together with two diaphragms to yield a pressure ratio of 3:1 [e.g., 5.9 bar (85 psig) air inlet will develop pump discharge pressures up to 17.2 bar (250 psig)]. Air is simultaneously directed behind the amplifier piston as well as one of the diaphragms via specialized air manifold porting. The sum of the two surface areas is three times that of the diaphragm. Therefore, the discharge is amplified by a 3:1 pressure output ratio.



Section 4

DIMENSIONAL DRAWING

H1500 HS Vertically-Mounted, Center-Ported with Ball/Mushroom Valve

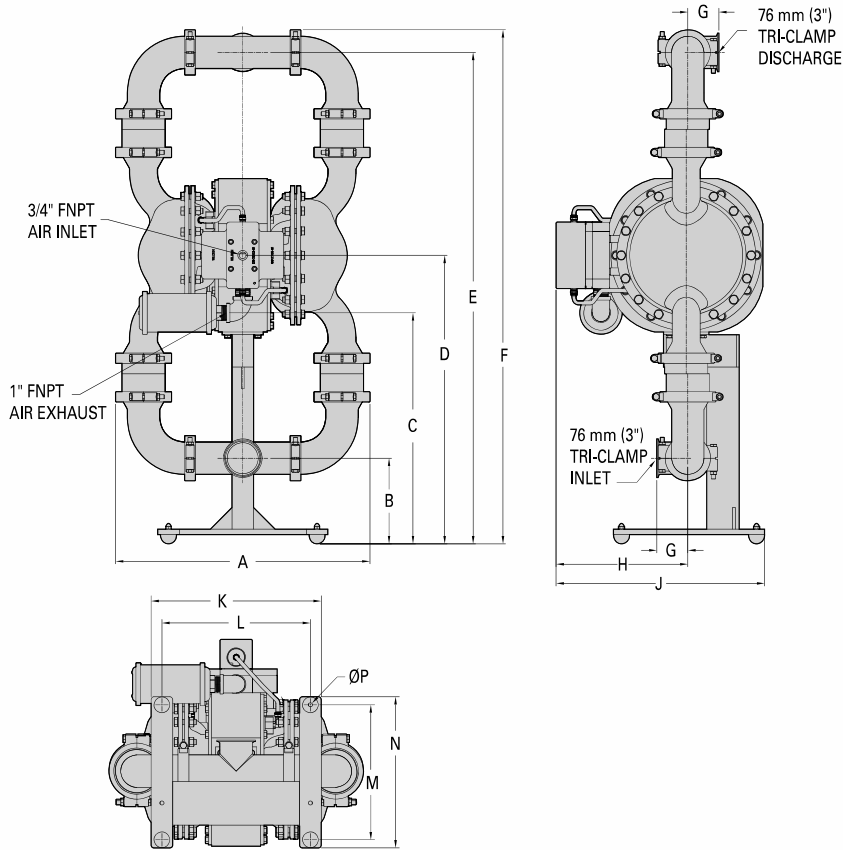

DIMENSIONS

ITEM	METRIC (mm)	STANDARD (inch)
A	599	23.6
B	201	7.9
C	543	21.4
D	678	26.7
E	1156	45.5
F	1209	47.6
G	74	2.9
H	310	12.2
J	490	19.3
K	401	15.8
L	351	13.8
M	318	12.5
N	356	14.0
P	010	0.4

LW0115 REV. A

SUCTION LIFT CURVES

H1500 HS SUCTION – LIFT CAPABILITY

Suction-lift curves are calibrated for pumps operating at 305 m (1,000') above sea level. This chart is meant to be a guide only. There are many variables that can affect your pump's operating characteristics. The number of intake and discharge elbows, viscosity of pumping fluid, elevation (atmospheric pressure) and pipe friction loss all affect the amount of suction lift your pump will attain.

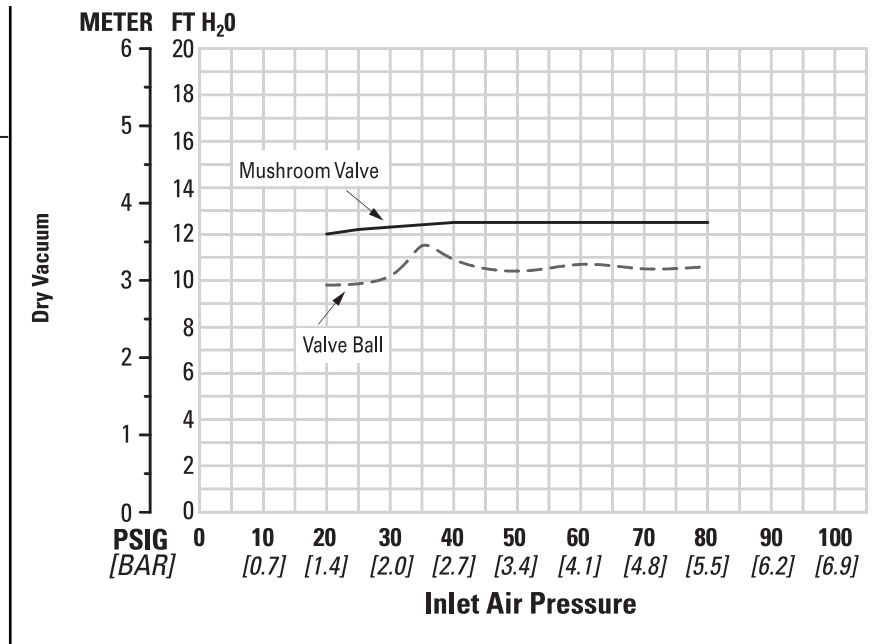

Section 6

Suggested Installation, Operation, Maintenance and Troubleshooting

Wilden pumps are designed to meet the performance requirements of even the most demanding pumping applications. They have been designed and manufactured to the highest standards and are available in a variety of liquid path materials to meet your chemical resistance needs. Refer to the performance section of this manual for an in-depth analysis of the performance characteristics of your pump. Wilden offers the widest variety of elastomer options in the industry to satisfy temperature, chemical compatibility, abrasion resistance and flex concerns.

The suction pipe size should be equivalent or larger than the diameter of the suction inlet on your Wilden pump. The suction hose must be non-collapsible, reinforced type as these pumps are capable of pulling a high vacuum. Discharge piping should also be equivalent or larger than the diameter of the pump discharge to minimize friction losses. It is critical that all fittings and connections are airtight or a reduction or loss of pump suction capability will result.



CAUTION: All fittings and connections must be airtight. Otherwise, pump suction capability will be reduced or lost.

Months of careful planning, study and selection efforts can result in unsatisfactory pump performance if installation details are left to chance. Premature failure and long-term dissatisfaction can be avoided if reasonable care is exercised throughout the installation process.

Location

Noise, safety and other logistical factors usually dictate where equipment will be situated on the production floor. Multiple installations with conflicting requirements can result in congestion of utility areas, leaving few choices for additional pumps.

Within the framework of these and other existing conditions, every pump should be located in such a way that the following key factors are balanced against each other to maximum advantage:

- **Access:** First of all, the location should be accessible. If it's easy to reach the pump, maintenance personnel will have an easier time carrying out routine inspections and adjustments. Should major repairs become necessary, ease of access can play a key role in speeding the repair process and reducing total downtime.
- **Air Supply:** Every pump location should have an air line large enough to supply the volume of air necessary to achieve the desired pumping rate. Do not exceed the maximum rated air pressure.

For best results, the pumps should use a 5 μ (micron) air filter, needle valve and regulator. The use of an air filter before the pump will ensure that the majority of any pipeline contaminants will be eliminated.

- **Solenoid Operation:** When operation is controlled by a solenoid valve in the air line, three-way valves should be used. This valve allows trapped air between the valve and the pump to bleed off, which improves pump performance. You can estimate pumping volume by counting the number of strokes per minute, and then multiplying that figure by the displacement per stroke.
- **Muffler:** Sound levels are reduced below OSHA specifications using the standard Wilden muffler. Other mufflers can be used to further reduce sound levels, but they usually reduce pump performance.

- **Elevation:** Selecting a site that is well within the pump's dynamic lift capability will assure that loss-of-prime issues will be eliminated. In addition, pump efficiency can be adversely affected if proper attention is not given to site location.

- **Piping:** Final determination of the pump site should not be made until the piping challenges of each possible location have been evaluated. The impact of current and future installations should be considered ahead of time to make sure that inadvertent restrictions are not created for any remaining sites.

The best choice possible will be a site involving the shortest and straightest hook-up of suction and discharge piping. Unnecessary elbows, bends and fittings should be avoided. Pipe sizes should be selected to keep friction losses within practical limits. All piping should be supported independently of the pump. In addition, the piping should be aligned to avoid placing stress on the pump fittings.

Flexible hose can be installed to aid in absorbing the forces created by the natural reciprocating action of the pump. If the pump is to be bolted down to a solid location, a mounting pad placed between the pump and the foundation will assist in minimizing pump vibration. Flexible connections between the pump and rigid piping will also assist in minimizing pump vibration. If quick-closing valves are installed at any point in the discharge system, or if pulsation within a system becomes a problem, a surge suppressor (SD Equalizer[®]) should be installed to protect the pump, piping and gauges from surges and water hammer.

If the pump is to be used in a self-priming application, make sure that all connections are airtight and that the suction lift is within the model's ability.



NOTE: Materials of construction and elastomer material have an effect on suction-lift parameters. Please refer to the performance section for specifics.

When pumps are installed in applications involving flooded suction or suction head pressures, a gate valve should be installed in the suction line to permit closing of the line for pump service.

Pumps in service with a positive suction head are most efficient when inlet pressure is limited to 0.5–0.7 bar (7–10 psig). Premature diaphragm failure may occur if positive suction is 0.7 bar (10 psig) and higher.

Single-Point Exhaust

Pro-Flo SHIFT pumps can be used for submersible applications, when using the Pro-Flo SHIFT single-point exhaust option.



CAUTION: All Wilden pumps are capable of passing solids. A strainer should be used on the pump intake to ensure that the pump's rated solids capacity is not exceeded.

Suggested Installation, Operation, Maintenance and Troubleshooting

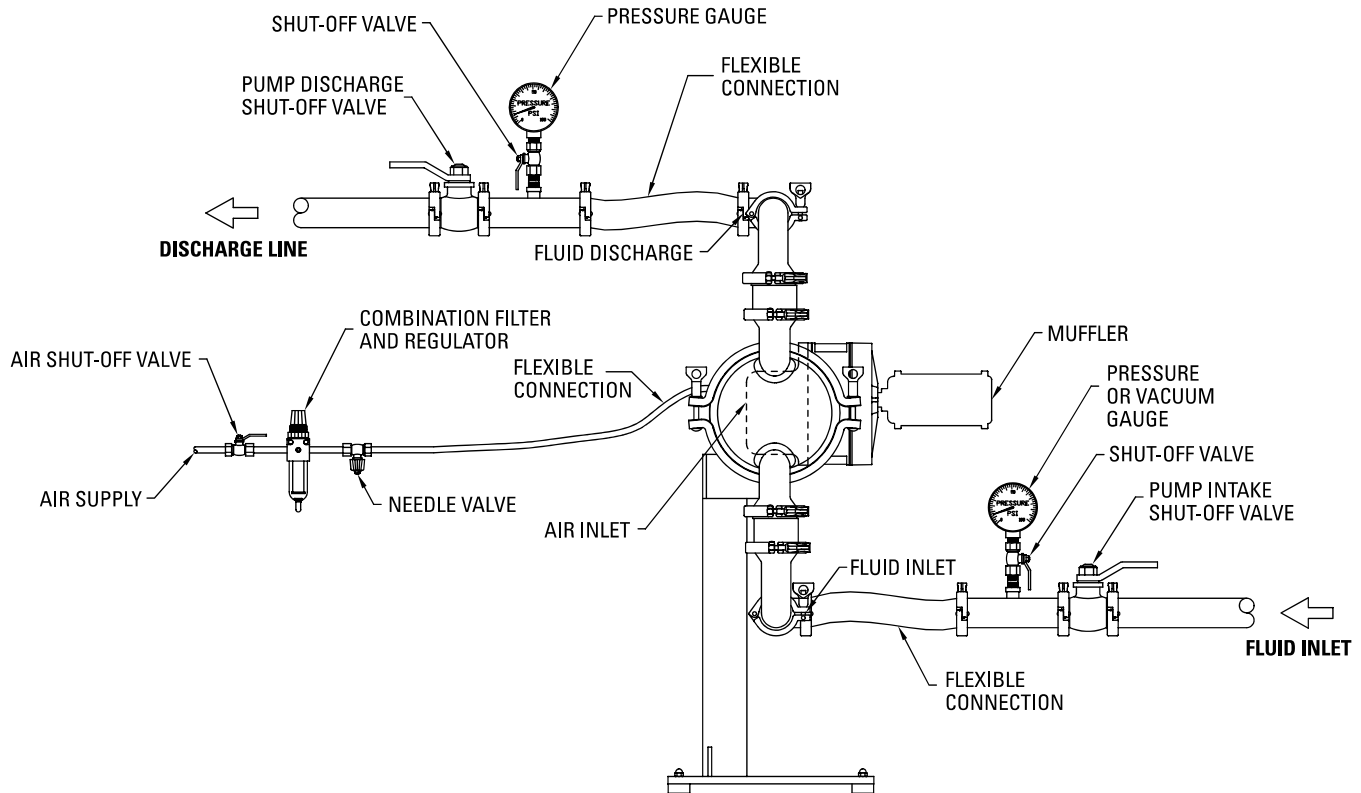

NOTE: In the event of a power failure, the air shut-off valve should be closed, if restarting of the pump is not desirable once power is regained.

Air-Operated Pumps: To stop the pump from operating in an emergency situation, simply close the air shut-off valve (user-supplied) installed in the air supply line. A properly functioning valve will stop the air supply to the pump, therefore stopping output. This air shut-off valve should be located far enough away from the pumping equipment such that it can be reached safely in an emergency situation.

Operation

The Pro-Flo SHIF pumps are pre-lubricated and do not require in-line lubrication. Additional lubrication will not damage the pump. However, if the pump is heavily lubricated by an external source, the pump's internal lubrication may be washed away. If the pump is then moved to a nonlubricated location, it may need to be disassembled and re-lubricated as described in "Disassembly/ Reassembly" on page 13.

Pump discharge rate can be controlled by limiting the volume and/or pressure of the air supply to the pump. An air regulator is used to

regulate air pressure. A needle valve is used to regulate volume. Pump discharge rate also can be controlled by throttling the pump discharge by partially closing a valve in the discharge line of the pump. This action increases friction loss, which reduces flow rate. (See "Performance" on page 8.) This is useful when the need exists to control the pump from a remote location. When the pump discharge pressure equals or exceeds the air supply pressure, the pump will stop. No bypass or pressure relief valve is needed, and pump damage will not occur. The pump has reached a "deadhead" situation and can be restarted by reducing the fluid discharge pressure or increasing the air inlet pressure. Wilden Pro-Flo SHIF pumps run solely on compressed air and do not generate heat.

Therefore, your process fluid temperature will not be affected.

Maintenance and Inspections

Because each application is unique, maintenance schedules may be different for every pump. Frequency of use, line pressure, viscosity and abrasiveness of process fluid all affect the parts life of a Wilden pump. Periodic inspections have been found to offer the best means for preventing unscheduled pump downtime. Personnel familiar with the pump's construction and service should be informed of any abnormalities that are detected during operation.



Suggested Installation, Operation, Maintenance and Troubleshooting

Troubleshooting

Pump will not run or runs slowly.

1. Remove plug from pilot spool exhaust.
 2. Ensure that the air inlet pressure is at least 0.4 bar (5 psig) above startup pressure and that the differential pressure (the difference between air inlet and liquid discharge pressures) is not less than 0.7 bar (10 psig).
 3. Check air inlet filter for debris (see "Suggested Installation, Operation, Maintenance and Troubleshooting" on page 10).
 4. Check for extreme air leakage (blow by) that would indicate worn seals/bores in the air valve, pilot spool and main shaft.
 5. Disassemble the pump and check for obstructions in the air passageways or objects that would obstruct the movement of internal parts.
 6. Check for sticking ball check valves.
 - a. If material being pumped is not compatible with pump elastomers, swelling may occur. Replace ball check valves and seals with proper elastomers.
 - b. Also, as the check valve balls wear out, they become smaller and can become stuck in the seats. In this case, replace balls and seats.
 7. Check for any broken inner piston that would cause the air valve spool to be unable to shift.
 8. Remove plug from pilot spool exhaust.
3. Check for sticking ball check valves.
 - a. If material being pumped is not compatible with pump elastomers, swelling may occur. Replace ball check valves and seals with proper elastomers.
 - b. Also, as the check valve balls wear out, they become smaller and can become stuck in the seats. In this case, replace balls and seats.
 4. Check tightness of inlet and discharge connections.

Pump air valve freezes.

1. Check for excessive moisture in the compressed air.
 - a. Either install a dryer or a hot air generator for compressed air.
 - b. Alternatively, you may use coalescing filter to remove the water from the compressed air in some applications.

Air bubbles in pump discharge.

1. Check for a ruptured diaphragm.
2. Check tightness of outer pistons (see Disassembly/Reassembly on page 13).
3. Check tightness of fasteners and integrity of O-rings and seals, especially at intake manifold.
4. Ensure pipe connections are airtight.

Product comes out air exhaust.

1. Check for a diaphragm rupture.
2. Check the tightness of the outer pistons to the shaft.
3. Check tightness of fasteners that connect the inner piston to the outer piston

Pump runs, but little or no product flows.

1. Check for pump cavitation. Slow pump speed down to allow thick material to flow into liquid chambers.
2. Verify that vacuum required to lift liquid is not greater than the vapor pressure of the material being pumped (cavitation).

Section 7

Disassembly / Reassembly

Pump Disassembly

Tools Required:

- Hex wrenches
- Ratchet and socket set
- O-ring pliers
- Snap-ring pliers
- Torque wrench
- Combination wrench set and/or adjustable wrenches
- Vise equipped with soft jaws (such as plywood, plastic or other suitable materials)



CAUTION: Before any maintenance or repair is attempted, the compressed air line to the pump should be disconnected and all air pressure allowed to bleed from the pump. Disconnect all intake, discharge and air lines. Drain the pump by turning it upside down and allowing any fluid to flow into a suitable container. Be aware of any hazardous effects of contact with your process fluid container. Be aware of any hazardous effects of contact with your process fluid.



NOTE: The model photographed for these instructions incorporates PTFE diaphragms.

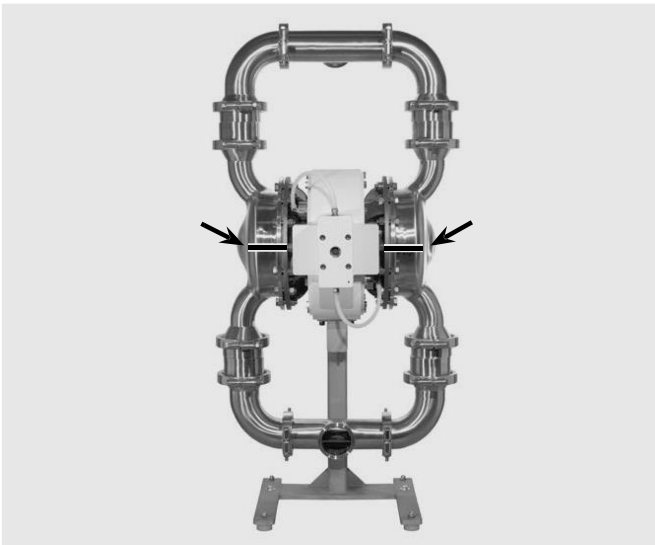

Step 1

Prior to assembly, place alignment marks on the liquid chambers and air chambers to assist with proper alignment during reassembly.

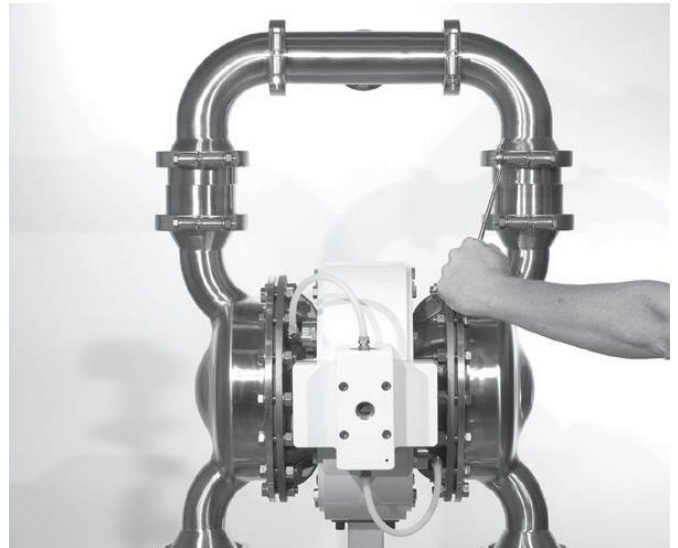

Step 2

Loosen the fasteners for the clamp band using an appropriate-sized wrench.



Disassembly / Reassembly

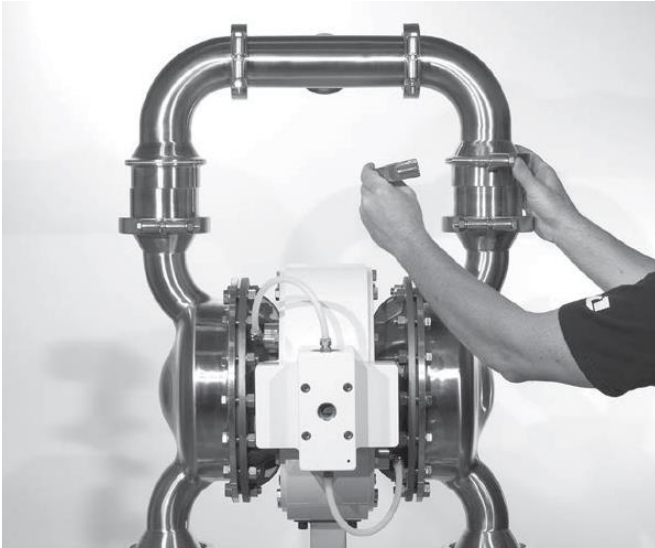

Step 3
Remove the clamp band assemblies on discharge manifold.

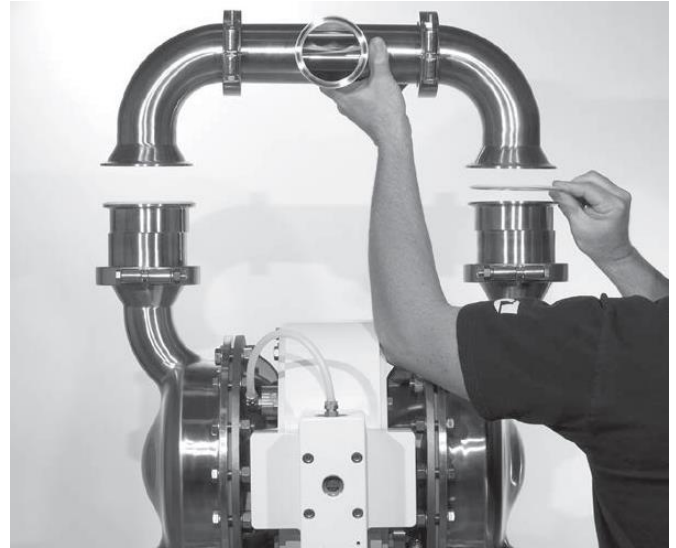

Step 4
Remove the discharge manifold and manifold gaskets.

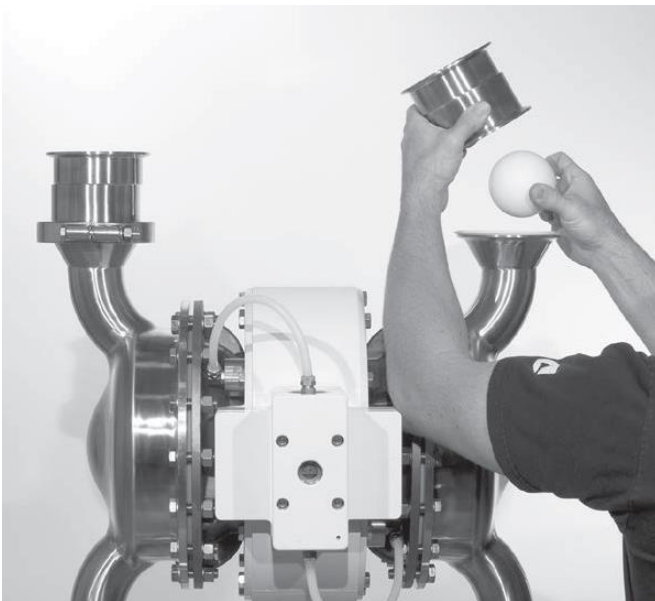

Step 5
Next, remove the clamp bands that secure the ball valve housing to the liquid chamber. Remove the ball valve housing, valve ball and gasket. After removing ball valve housing, inspect for abrasion in the ball cage area.



NOTE: If your pump is fitted with a mushroom valve, remove the mushroom valve housing, mushroom valve and gasket.

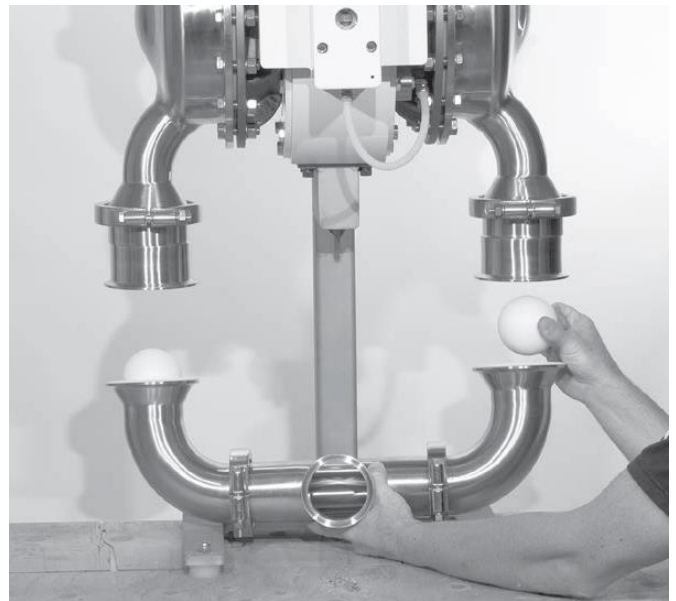

Step 6
Loosen the nut and remove the inlet manifold clamp bands. Next, remove the clamp bands that secure the valve housing to the liquid chamber. After removing ball valve housing, inspect for abrasion in the inlet manifold area.

Disassembly / Reassembly



Step 7

Next, remove the ball valve housing, valve ball and gasket from liquid chamber. To ensure proper alignment during reassembly of manifold/liquid chamber interface, turn off-set portion of valve housing to the left or to the right. This procedure works for the inlet and discharge manifold connections.



Step 8

Inspect the ball valve housing and valve ball for signs of abrasion.

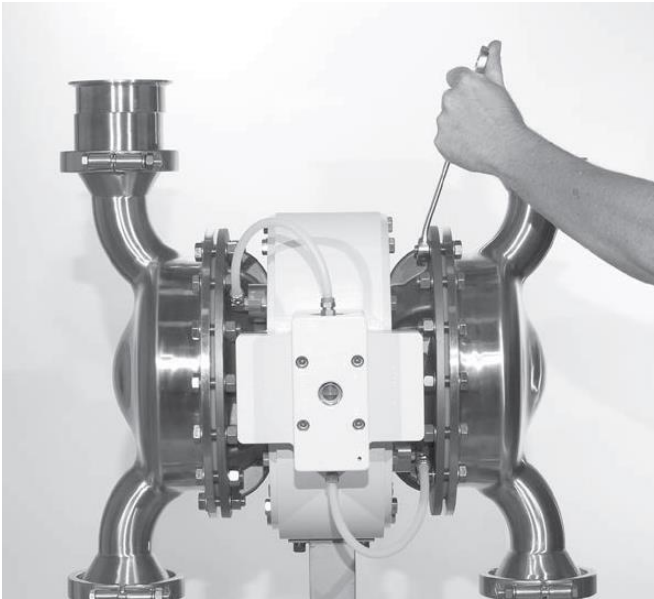

Step 9

Using the appropriate-sized wrenches, disconnect the inlet manifold from the center section.

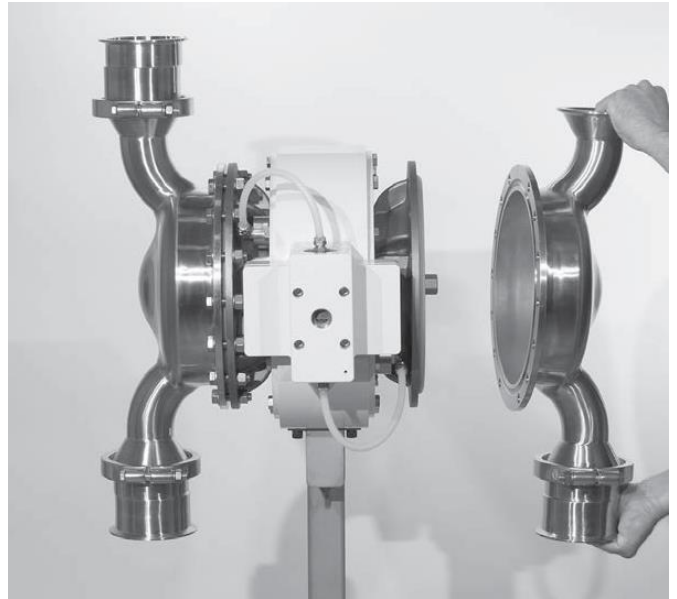

Step 10

Next, remove the liquid chamber from the center section assembly.

Disassembly / Reassembly

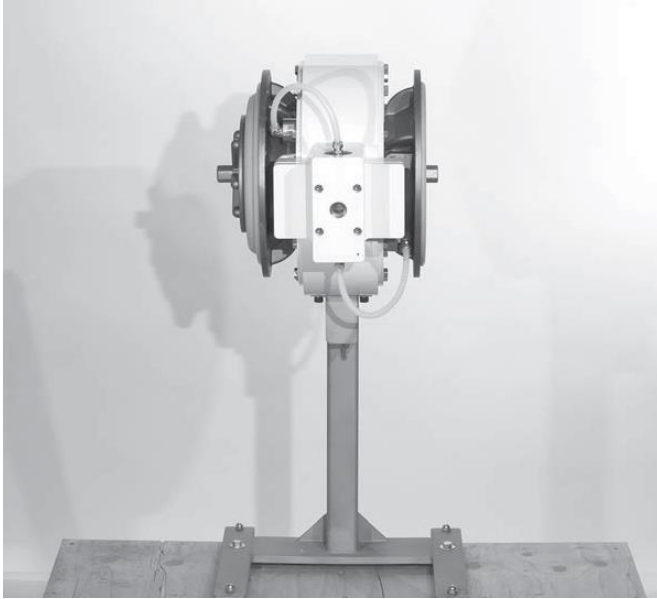

Step 11 (if applicable)

If your pump is fitted with an integral piston diaphragm (IPD), when you remove the liquid chamber you will notice that there is no outer piston.

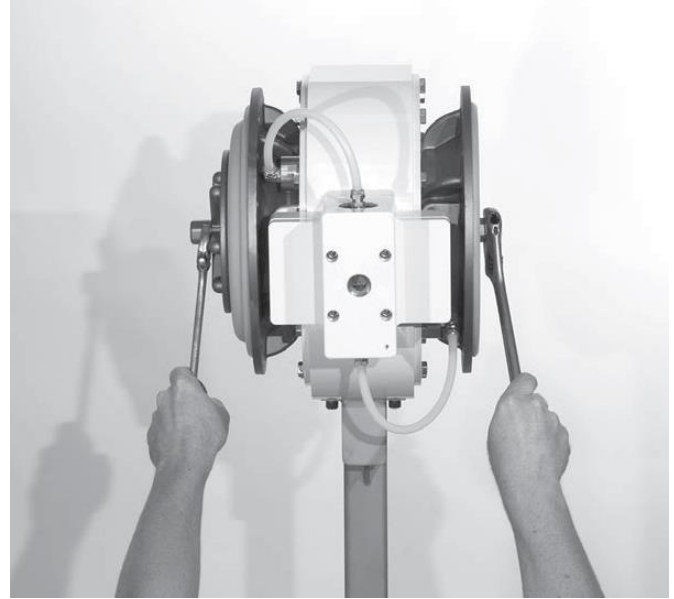

Step 12

Using appropriate-sized wrenches, turning in the opposite direction, loosen and remove one of the two (2) outer pistons.

⚠ NOTE: With an IPD, the procedure for removing the diaphragm is slightly different. In this case, simply grasp the diaphragm in two locations and turn in a counter-clockwise direction.

Disassembly / Reassembly

Air Valve / Center Section Disassembly

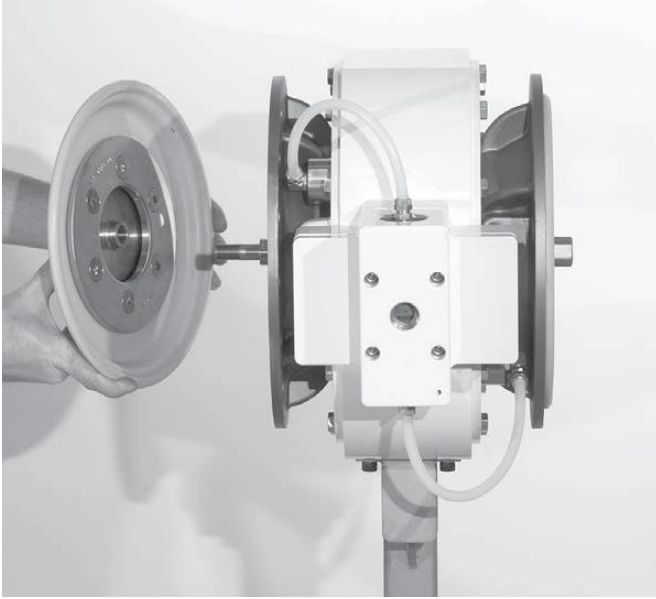

Step 13

After loosening, remove the outer piston and diaphragm assembly.

 **NOTE:** If using an IPD, un-thread from the shaft.

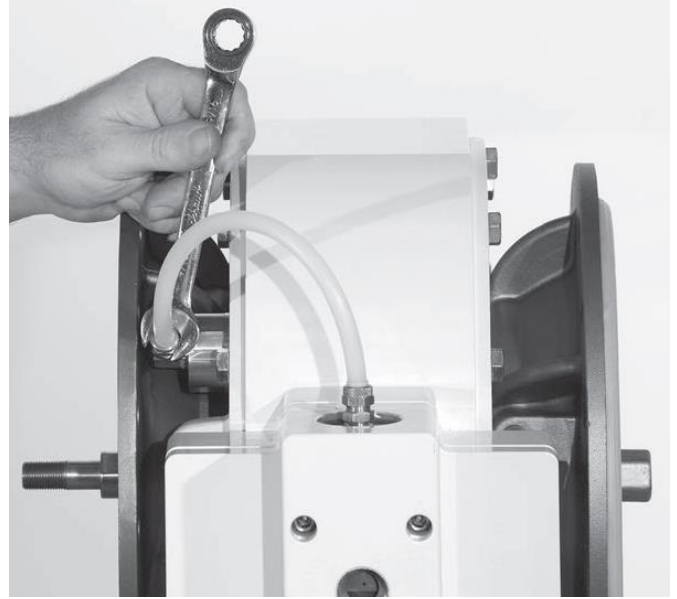

Step 14

Loosen tubing nuts located at each pressure relief valve. Next, loosen pipe fitting and elbow. This will allow easy access to the relief valve. Using the appropriate-sized wrench, remove each pressure relief valve.

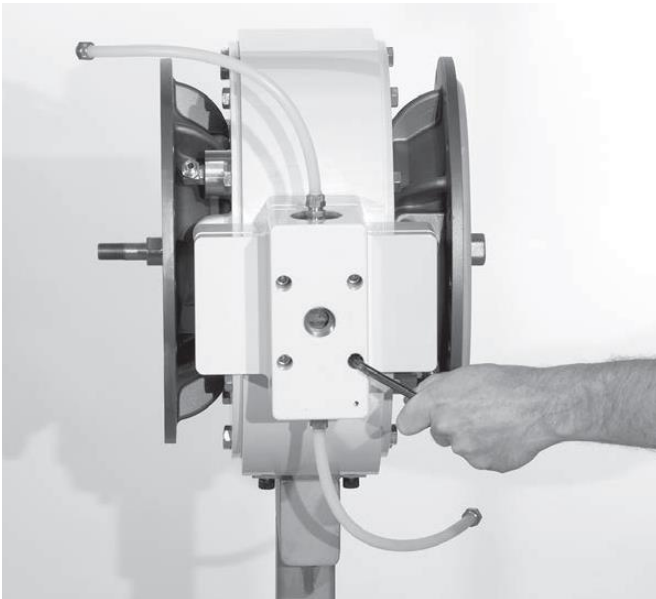

Step 15

Using the appropriate-sized wrench, remove the fasteners that connect the air valve and air valve gasket to the center section.

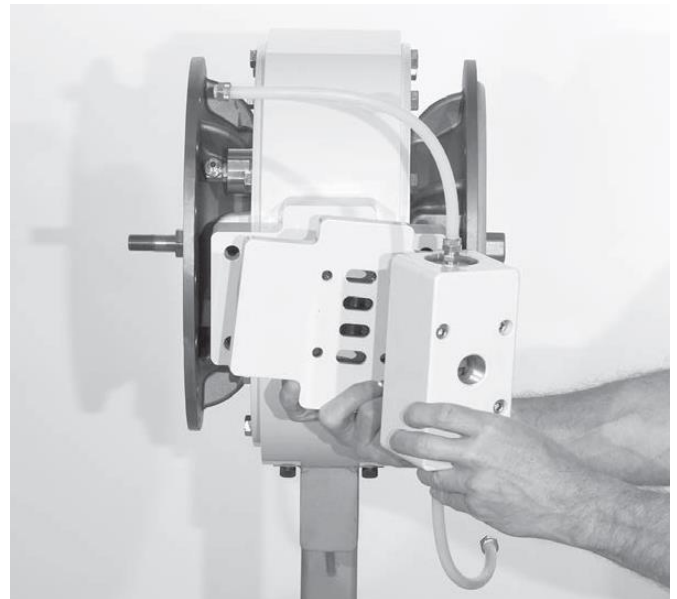

Step 16

Lift air valve and isolator cover away from pump.

Disassembly / Reassembly

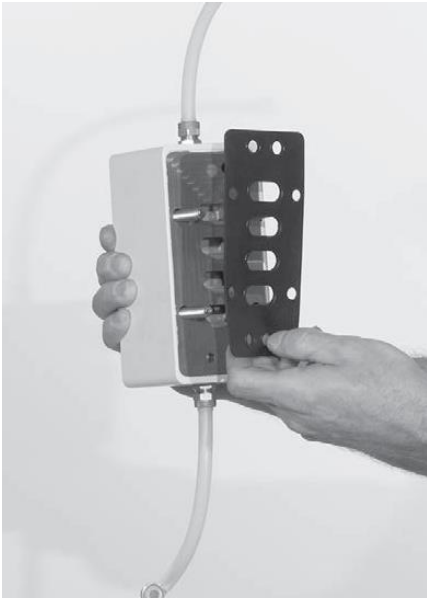

Step 17

Inspect air valve gasket for nicks, gouges, chemical attack and replace if necessary with genuine Wilden® parts.



Step 18

Using a pair of snap-ring pliers, remove one snap-ring from the air valve body. Inspect air piston, air valve body and air valve end cap for nicks, gouges, chemical attack or abrasive wear.



HINTS & TIPS: Using an air nozzle, alternately pressurize top and bottom bleeder holes until the top end cap is forced from air valve body.



CAUTION: End cap may come out with considerable force. Position a shop rag or equivalent over the top end cap to ensure that the end cap doesn't harm the pump technician or anyone else in the immediate area of the pump.

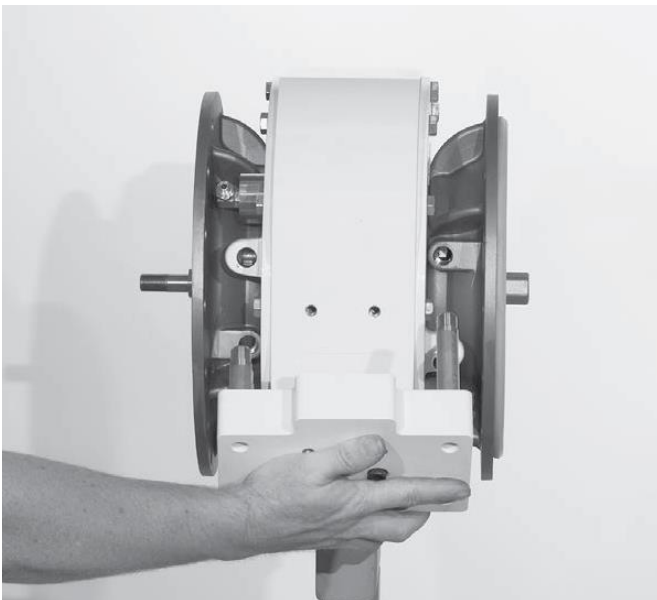

Step 19

Using a hex wrench, remove the two (2) air-valve manifold fasteners.

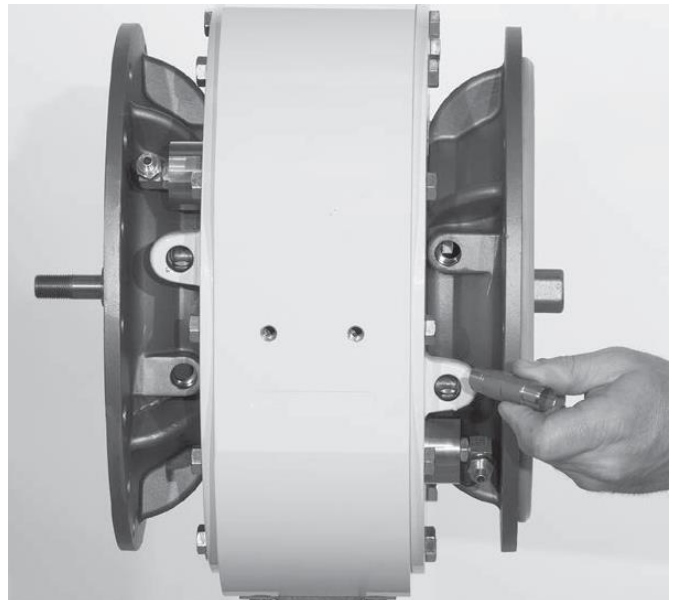

Step 20

Located behind the air valve manifold are four (4) tubes [two short (2) and two (2) longer]. Remove all four (4) tubes from pump.

Disassembly / Reassembly

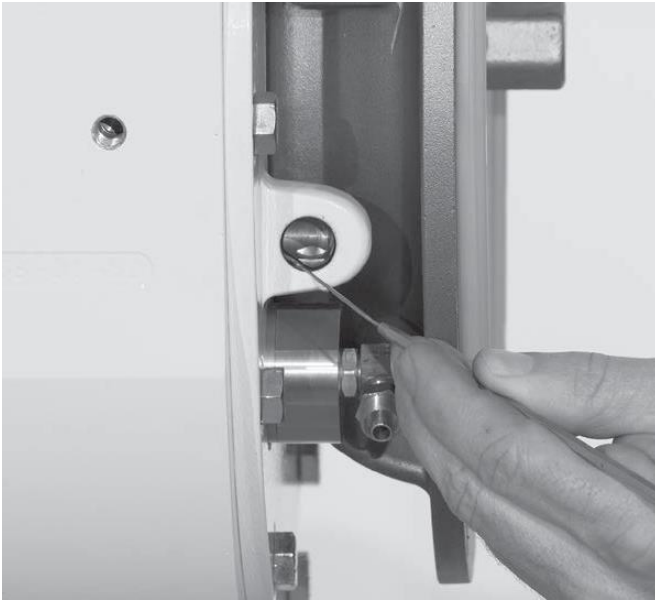

Step 21

After removing tubes inspect or replace the O-rings as needed.

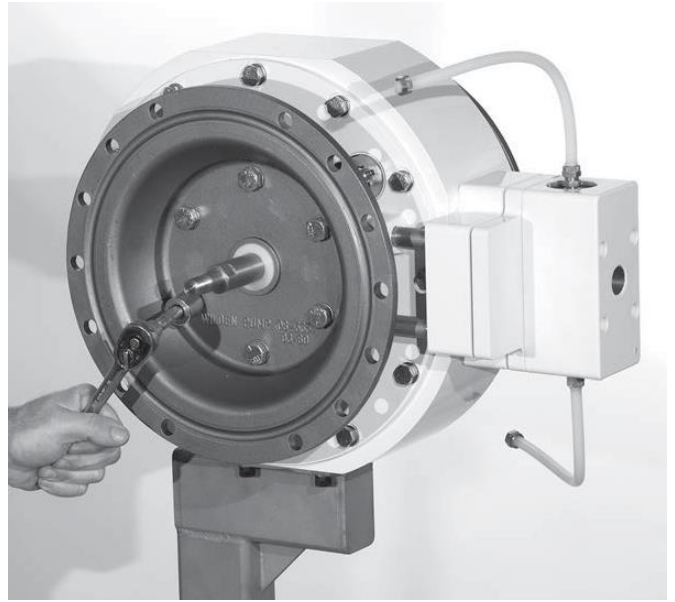

Step 22

Using the appropriate-sized wrench, remove the air chamber fasteners.

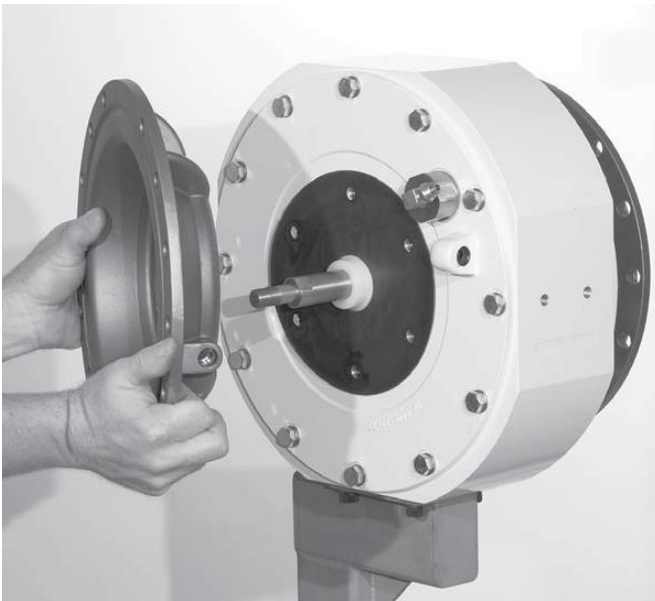

Step 23

Remove the air chamber fasteners and gasket.

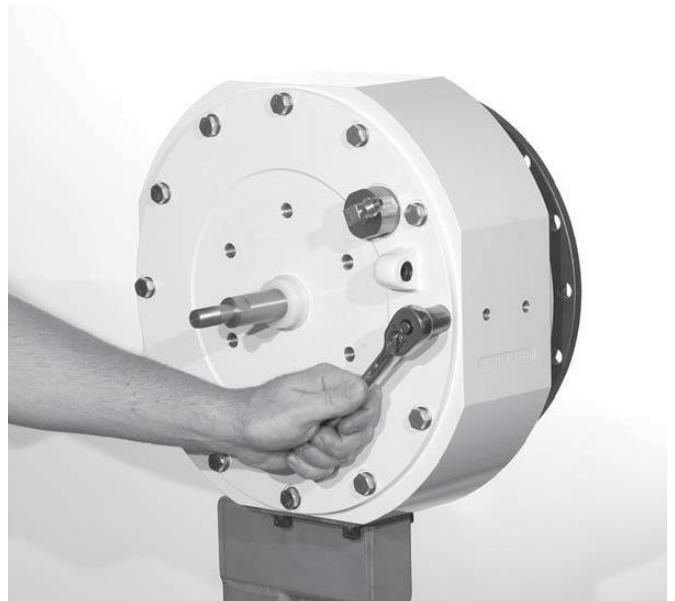

Step 24

Using a socket wrench, unbolt the power cylinder cover from the center section.

Disassembly / Reassembly

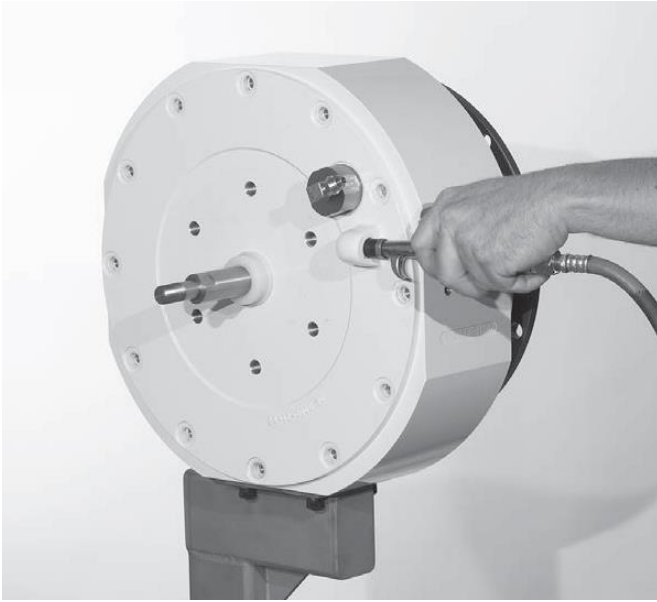

Step 25

Using an air nozzle with a rubber tip, apply air to the air manifold tube port.

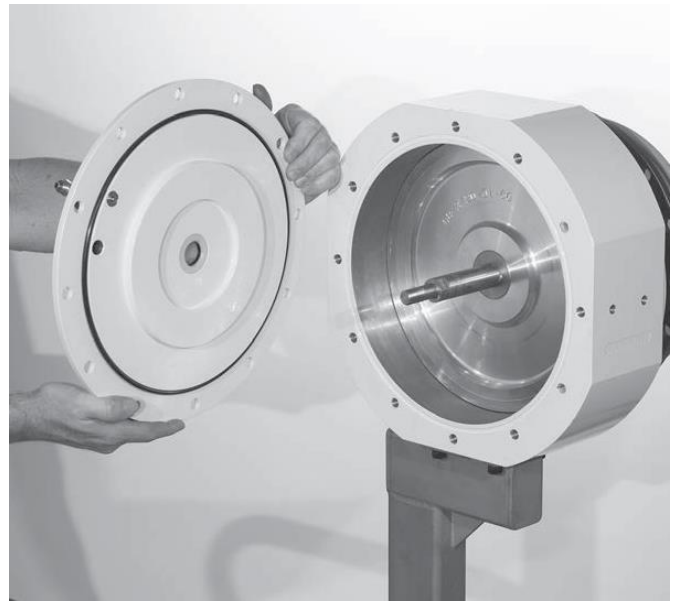

Step 26

This will force the power cylinder cover away from the power cylinder body. Inspect shaft bushing seals and O-ring on power cylinder cover for damage.

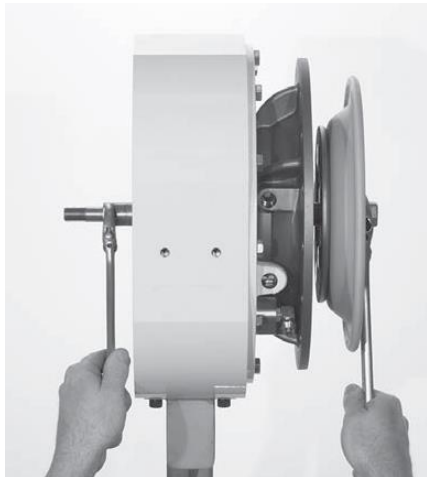

Step 27

Using two appropriate-sized wrenches, turning in the opposite direction, loosen and remove shaft diaphragm assembly.

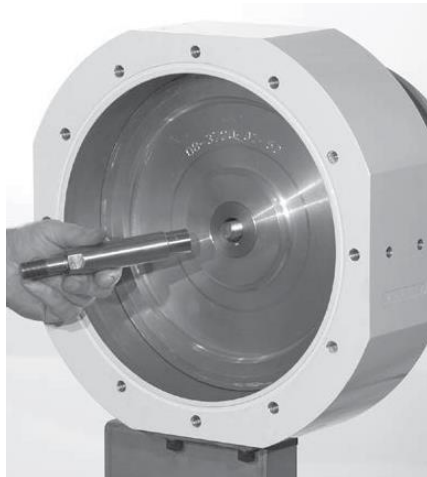

Step 28

Remove the outer piston, diaphragm and shaft assembly from the air chamber.

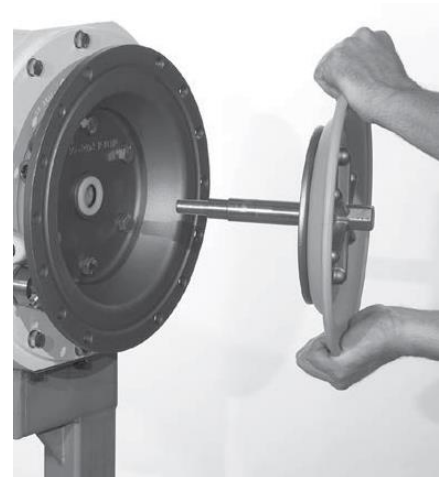

Disassembly / Reassembly



Step 29

Using an air nozzle with a rubber tip, apply air to the air manifold tube. This will force the power cylinder piston away from the power cylinder body.

Continue to apply air pressure to the air manifold tube port until the power cylinder piston is moved out of the power cylinder body.



Step 30

Retain the shaft bushings for use in reassembly.

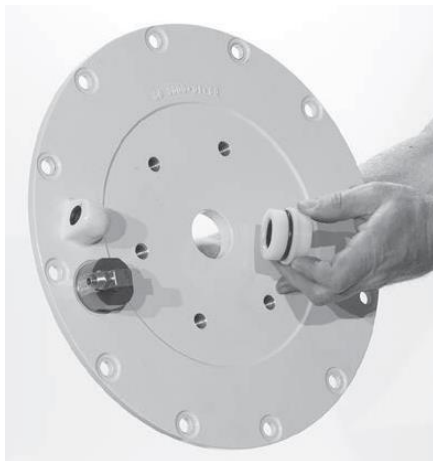

Step 31

Inspect the center section cover and bushings. Replace if necessary with genuine Wilden® parts.

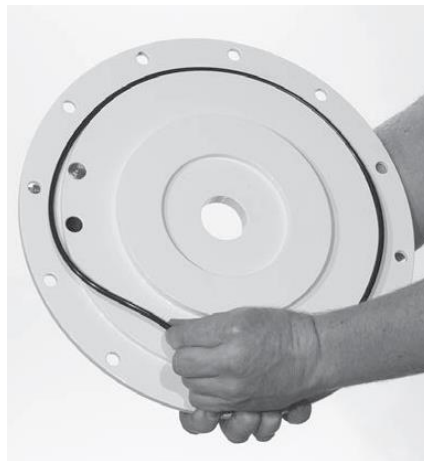

Step 32

Inspect the O-ring cover for nicks, gouges, chemical attack or abrasion. Replace if necessary with genuine Wilden® parts.



Step 33

Using a hex wrench, remove the fasteners that connect the inner piston to the diaphragm assembly. Inspect diaphragm for nicks, gouges, chemical attack or abrasion. Replace if necessary with genuine Wilden® parts.

Power Cylinder Reassembly

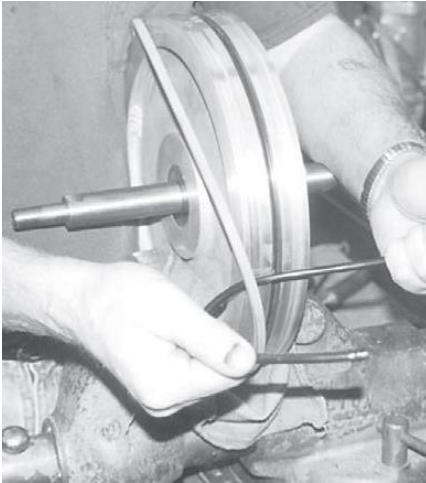

Step 1

After attaching the diaphragm shaft and bushing to the power cylinder piston, place power cylinder in vice with soft jaws (careful to not damage piston). Next, install new slipper seal.



HINTS & TIPS: Using a strip of material (like an old O-ring), slide the material back and forth until the slipper seal is positioned above the center groove.



Step 2

Next, place the power cylinder and power cylinder piston on top of the two blocks of wood or equivalent.

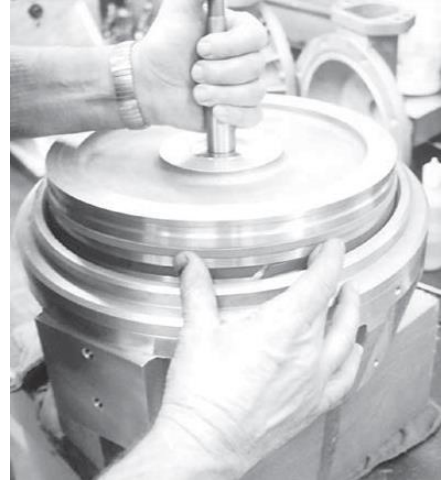

Step 3

Insert new guide rings in outer grooves. Very gently, begin to maneuver the power cylinder piston into the power cylinder body.



HINTS & TIPS: A conical (tapered) piece of cylindrical sheet material or equivalent can be used to hold the guide rings in place as the power cylinder piston slides into the power cylinder body

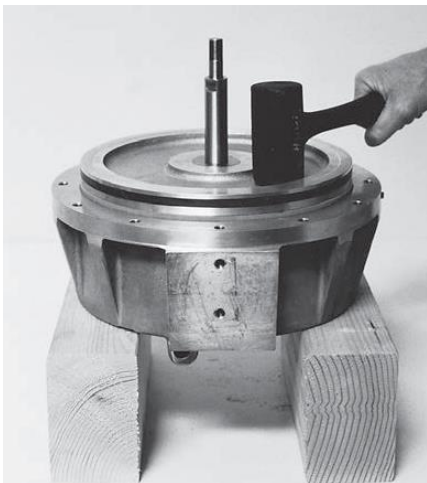

Step 4

Using a rubber mallet, lightly tap power cylinder piston in a circular fashion until piston is maneuvered completely into power cylinder body. When performing this task, use caution to not damage the guide rings or slipper seal.

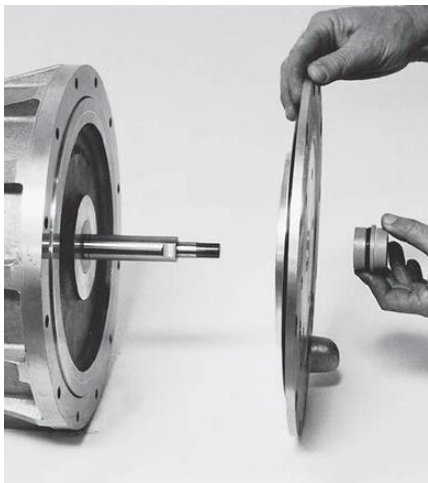

Step 5

As a last step, install power cylinder cover and bushing to power cylinder body and secure with fasteners provided.

REASSEMBLY HINTS & TIPS

Upon performing applicable maintenance to the air distribution system, the pump can now be reassembled. Please refer to the disassembly instructions for photos and parts placement. To reassemble the pump, follow the disassembly instructions in reverse order. The air distribution system needs to be assembled first, then the diaphragms and finally the wetted path.

The following tips will assist in the assembly process:

- Lubricate air valve bore, center section shaft and pilot spool bore with NLGI grade 2 white EP bearing grease or equivalent.
- Clean the inside of the center section shaft bore to ensure no damage is done to new shaft seals.
- A small amount of NLGI grade 2 white EP bearing grease can be applied to the muffler and air valve gaskets to locate gaskets during assembly.
- Make sure that the exhaust port on the muffler plate is centered between the two exhaust ports on the center section.
- Stainless bolts should be lubed to reduce the possibility of seizing during tightening.
- Use a mallet to tap lightly on the large clamp bands to seat the diaphragm before tightening.

PRO-FLO® SHIFT MAXIMUM TORQUE SPECIFICATIONS

Description of Part	Torque
Air Valve	11.3 N.m (100 in-lb)
Dial set screw	11.3 N.m (100 in-lb)
Outer pistons, all diaphragms	47.5 N.m (35 in-lb)
Center block-to-stand bolt	44.7 N.m (33 in-lb)
Center block-to-bushing bolt	44.7 N.m (33 in-lb)
Locking Pin	44.7 N.m (33 in-lb)
Anti-Rotation Bolt	67.8 N.m (50 in-lb)



NOTE: To ensure proper alignment during reassembly of manifold/liquid chamber interface, turn off-set portion of valve housing to the left or to the right. This procedure works for the inlet manifold and discharge manifold connections

Disassembly / Reassembly

Shaft Seal Installation

Pre-Installation

Once all of the old seals have been removed, the inside of the bushing should be cleaned to ensure no debris is left that may cause premature damage to the new seals.

Installation

1. Wrap electrical tape around each leg of the needle-nose pliers (heat shrink tubing may also be used). This is done to prevent damaging the inside surface of the new seal.
2. With a new seal in hand, place the two legs of the needle-nose pliers inside the seal ring. (See Figure A.)
3. Open the pliers as wide as the seal diameter will allow, then with two fingers pull down on the top portion of the seal to form a kidney shape. (See Figure B.)
4. Lightly clamp the pliers together to hold the seal into the kidney shape. Be sure to pull the seal into as tight of a kidney shape as possible, this will allow the seal to travel down the bushing bore easier.
5. With the seal clamped in the pliers, insert the seal into the bushing bore and position the bottom of the seal into the correct groove. Once the bottom of the seal is seated in the groove, release the clamp pressure on the pliers. This will allow the seal to partially snap back to its original shape.
6. After the pliers are removed, you will notice a slight bump in the seal shape. Before the seal can be properly resized, the bump in the seal should be removed as much as possible. This can be done with either the Phillips screwdriver or your finger. With either the side of the screwdriver or your finger, apply light pressure to the peak of the bump. This pressure will cause the bump to be almost completely eliminated.
7. Lubricate the edge of the shaft with NLGI grade 2 white EP bearing grease.
8. Slowly insert the center shaft with a rotating motion. This will complete the resizing of the seal.
9. Perform these steps for the remaining seals.

Tools

The following tools can be used to aid in the installation of the new seals:

- Needle-Nose Pliers
- Phillips Screwdriver
- Electrical Tape

Figure A

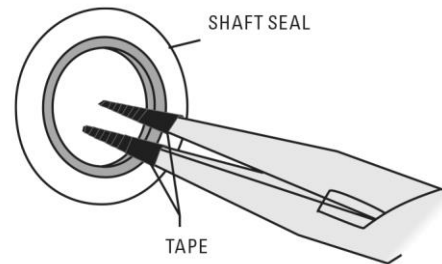
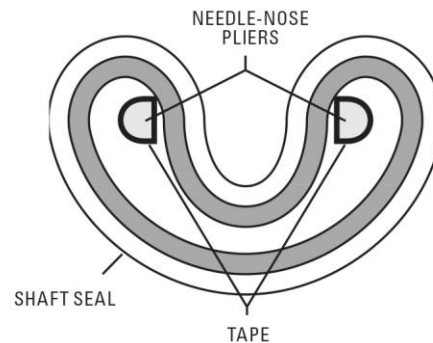

Figure B



Section 8

Clean - In - Place - CIP

The design of the Saniflo HS pump allows for ease of cleaning. The Saniflo HS pump can be cleaned in place without disassembly. Before any cleaning is attempted, ensure that the cleaning fluids are compatible with all wetted components.

For best cleaning results consider the following information prior to cleaning the Saniflo HS pump.

- Actual CIP effectiveness with pump user's product(s) and processes should be validated on location by the end user's quality assurance personnel to meet internal guidelines. Post cleaning swab test is one method to accomplish this.
- The pump user should establish periodic inspections with full tear down to verify that the CIP processes continue to be effective as first validated.
- Inlet pressure to the pump should not be greater than 0.7 bar (10 psig). Premature diaphragm failure may occur if greater than 0.7 bar (10 psig) is applied. If the pump is to be subjected to greater than 0.7 bar (10 psig), an optional diaphragm balancing device is suggested to eliminate the possibility of the diaphragms being forced against the air chamber and subsequently causing premature diaphragm failure.

The following are some details to consider when cleaning the Saniflo HS pump.

- The H1500 HS pump has been validated to clean equivalent to the inlet tubing of the same diameter. The cleaning chemical supplier should be consulted and advised of this for their chemical solution and application. The same guideline for duration of cleaning cycle and temperature of cleaning fluid apply.

- Suggested flow rate for the HS1500 HS pump is 100 gpm minimum/22.7 m³/hr (usually higher is better).
- Typical CIP temperature is 77°C to 82°C (170°F to 180°F).
- Typical chemicals include NaOH (sodium hydroxide) caustic for wash and light acid and sanitizers for rinse.
- Once an initial CIP regimen is established, it may need to be modified to accommodate specific process and product differences or requirements. The most common adjustments include:
 - Changing cleaning time (extended or reduced pre-rinse, wash, rinses)
 - Changing cleaning flow rate
- The cleaning variables are related so that a pump user may be able to reduce the cleaning time by increasing the flow rate or chemical mix.
- Chlorinated sanitizers are known to cause premature failure of stainless steel and should be avoided.
- Keep in mind, many CIP systems leave the pump filled with sanitizer and water and do not require draining.
- To drain a pump that is fitted with a non-swivel stand, the manifolds and liquid chambers must be removed if there is no automated CIP air-blow system in place. With the use of an automated CIP air-blow system, a pump fitted with a non-swivel stand can be cleaned in the same manner as a pump fitted with a swivel stand.
- An effective CIP system must have drain valves in the process line before and after the pump at the lowest points. The CIP system must be programmed to alternate between blowing air and opening the drain valves. This process must be repeated several times.

To Clean Pump

- Activate the CIP system while slowly cycling the pump.



NOTE: A typical the CIP temperature limit is 90°C (195°F). If the CIP temperature is greater than 90°C (195°F), damage to the pump may occur.



Section 9

EXPLODED VIEW AND PARTS LISTING

H1500 SANIFLO™ HS

EXPLODED VIEW

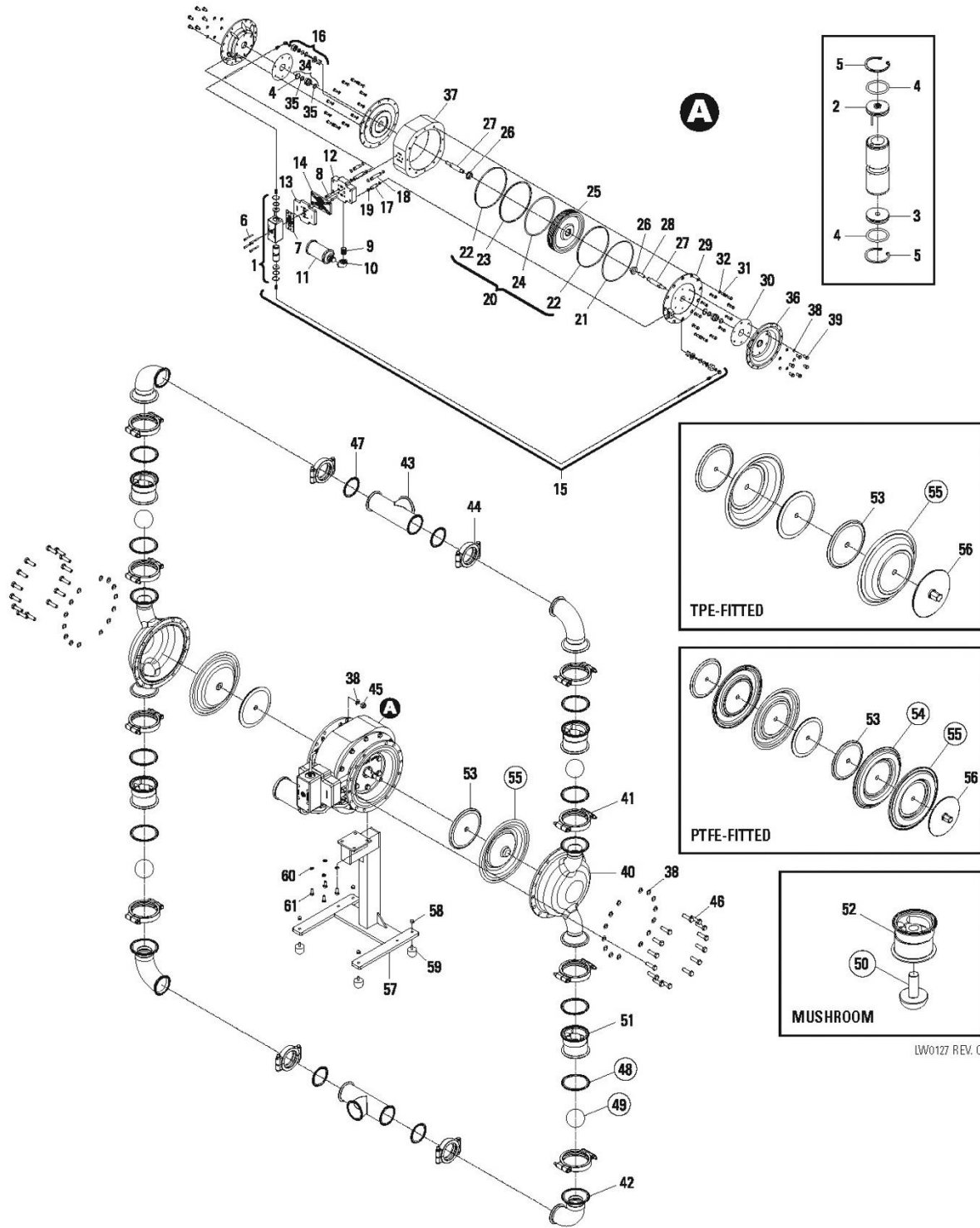

LW0127 REV. C

Exploded View and Parts List

Item	Part Description	Qty.	H1500/SZSII/... P/N	H1500/SSSII/... P/N
Air Distribution Components				
1	Air Valve Assembly¹	1	08-2003-45	08-2003-45
2	End Cap w/Guide Nylon	1	08-2306-23	08-2306-23
3	End Cap w/o Guide Nylon	1	08-2336-23	08-2336-23
4	O-Ring(-220)(Ø1.359xØ.139)	2	15-2390-52	15-2390-52
5	Retaining Ring	2	15-2650-03	15-2650-03
6	Screw, SHC, Air Valve (5/16"-18 x 2 3/4")	4	08-6000-03-83	08-6000-03-83
7	Air Valve Gasket	1	08-2601-52	08-2601-52
8	Screw, SHC, Manifold (3/8"-16 x 1 1/2")	2	99-6034-08	99-6034-08
9	Nipple, 1" NPT, Galvanized	1	08-7430-08-60	08-7430-08-60
10	Elbow, 90°, 1" NPT, Galvanized	1	08-7840-08-60	08-7840-08-60
11	Muffler	1	15-3510-99	15-3510-99
12	Manifold, Bottom Air Valve	1	08-2700-45	08-2700-45
13	Plate, Isolator Cover	1	08-2705-45	08-2705-45
14	Gasket, Air Valve Isolator	1	08-2603-52	08-2603-52
15	Relief Tube Assembly	2	08-9232-99-60	08-9232-99-60
16	Pressure Relief Valve Assembly	2	08-2742-99-60	08-2742-99-60
	Rebuild Pressure Relief Seal Kit	1	99-9346-99	99-9346-99
17	Pipe	2	08-7520-03-60	08-7520-03-60
18	Pipe	2	08-7510-03-60	08-7510-03-60
19	O-Ring (-114) Pipe (Ø.612 x Ø.103)	8	00-2870-52	00-2870-52
20	Power Piston Seal Kit ²	1	08-9210-99-60	08-9210-99-60
21	O-Ring (-379) Cover (Ø10.975 x Ø.210)	2	-	-
22	Guide Ring, Bronze-Filled	2	-	-
23	Slipper Seal, PTFE-Filled	1	-	-
24	O-Ring (-450) Piston (Ø10.475 x Ø.275)	1	-	-
25	Piston, Cylinder	1	08-3720-01-60	08-3720-01-60
26	Bushing, Cylinder Piston	2	08-3730-03-60	08-3730-03-60
27	Shaft	2	08-3800-03-60	08-3800-03-60
28	Stud, Shaft	1	08-6150-08-60	08-6150-08-60
29	Cover, Center Section	2	08-3000-45-60	08-3000-45-60
30	Gasket, Center Section	2	08-3260-52-60	08-3260-52-60
31	Screw, HHC (7/16"-14 x 1")	24	08-6260-08-60	08-6260-08-60
32	Washer (7/16")	24	08-6830-03-60	08-6830-03-60
33	Pipe Plug, 1/16" NPT	2	08-7030-08-60	08-7030-08-60
34	Bushing, Assembly Center Section ³	2	08-3300-99-60	08-3300-99-60
35	Glyd Ring	4	15-3210-55-225	15-3210-55-225
	O-Ring(-220)(Ø1.359xØ.139)	2	15-2390-52	15-2390-52
	Item No. 4			
36	Chamber, Air	2	08-3653-03-60	08-3653-03-60
37	Section, Center	1	08-3158-45-60	08-3158-45-60
38	Washer (1/2")	12	08-6840-03-60	08-6840-03-60
39	Screw, HHC (1/2"-13 x 1")	12	08-6132-08	08-6132-08

*See Elastomer Chart - Section 9

1 Air Valve Assembly includes item numbers 2, 3, 4, and 5.

2 Power Piston Seal Kit includes item numbers 21, 22, 23, and 24.

3 Bushing Assembly, Center Section, includes qty. 1 of item numbers 34 and 4.

4 Stand Assembly includes item numbers 58 and 59.

▲ Product Contact Components

All boldface items are primary wear parts.

Item	Part Description	Qty.	H1500/SZSII/... P/N	H1500/SSSII/... P/N
Wetted Path Components				
40	Chamber, Liquid CIP 3" EHEDG	2	15-5012-10-385P	15-5012-10-385P
41	Clamp Band Assy, 4"	8	15-7203-03	15-7203-03
42	Elbow, 3" EHEDG	4	15-5240-10-385P	15-5240-10-385P
43	T-Section, 3" EHEDG	2	15-5190-10-385P	15-5190-10-385P
44	Clamp Band, Assy, 3"	4	15-7103-03	15-7103-03
45	Hex Nut, (1/2"-13)	28	15-6420-03	15-6420-03
46	Screw, HHC (1/2"-13 x 1 3/4")	28	08-6190-08-60	08-6190-08-60
38	Washer (1/2")	56	08-6840-03-60	08-6840-03-60
Gaskets / Valve Balls / Mushroom Valve				
47	Gasket, 3"	4	*	*
48	Gasket, 4"	8	*	*
49	Valve Ball	4	*	*
50	Mushroom Valve	4	15-1096-55	15-1096-55
Check Valve Components				
51	Ball Cage, 3" EHEDG	4	15-5350-10-385P	15-5350-10-385P
52	Mushroom Valve Housing	4	15-5431-10-385P	15-5431-10-385P
FSIPD Components				
53	Piston, Inner, (Non-PTFE)	2	08-3700-03	
55	Diaphragm, Full Stroke IPD, Primary	2	08-1032-57	
TPE Components				
53	Piston, Inner, (Non-PTFE)	2		08-3700-03
55	Diaphragm, Primary	2		08-1011-57
56	Piston, Outer, (Non-PTFE)	2		08-4550-10-385P
PTFE Components				
53	Piston, Inner, (Non-PTFE)	2		08-3700-03
54	Diaphragm, Full Stroke PTFE, Backup	2		08-1065-57
55	Diaphragm, Full Stroke PTFE, Primary	2		08-1040-55
56	Piston, Outer, (Non-PTFE)	2		08-4550-10-385P
Fixed Stand Components				
57	Stand, Pump, PV Assy. ⁴	1	15-7653-10-385	15-7653-10-385
58	Nut, Cap, 5/16"-18, Pump Stand	4	08-6600-03-72	08-6600-03-72
59	Pad, Pump Stand	4	08-7670-20	08-7670-20
60	Washer, Flat (Ø.390 X Ø.625 X .063)	4	02-6730-03	02-6730-03
61	Screw, HHC, 3/8"-16 X 7/8"	4	08-6140-03	08-6140-03

LW0167 Rev. B



EXPLODED VIEW AND PARTS LISTING

H1500 SANIFLO™ HS

1935 /2004/EC

EXPLODED VIEW

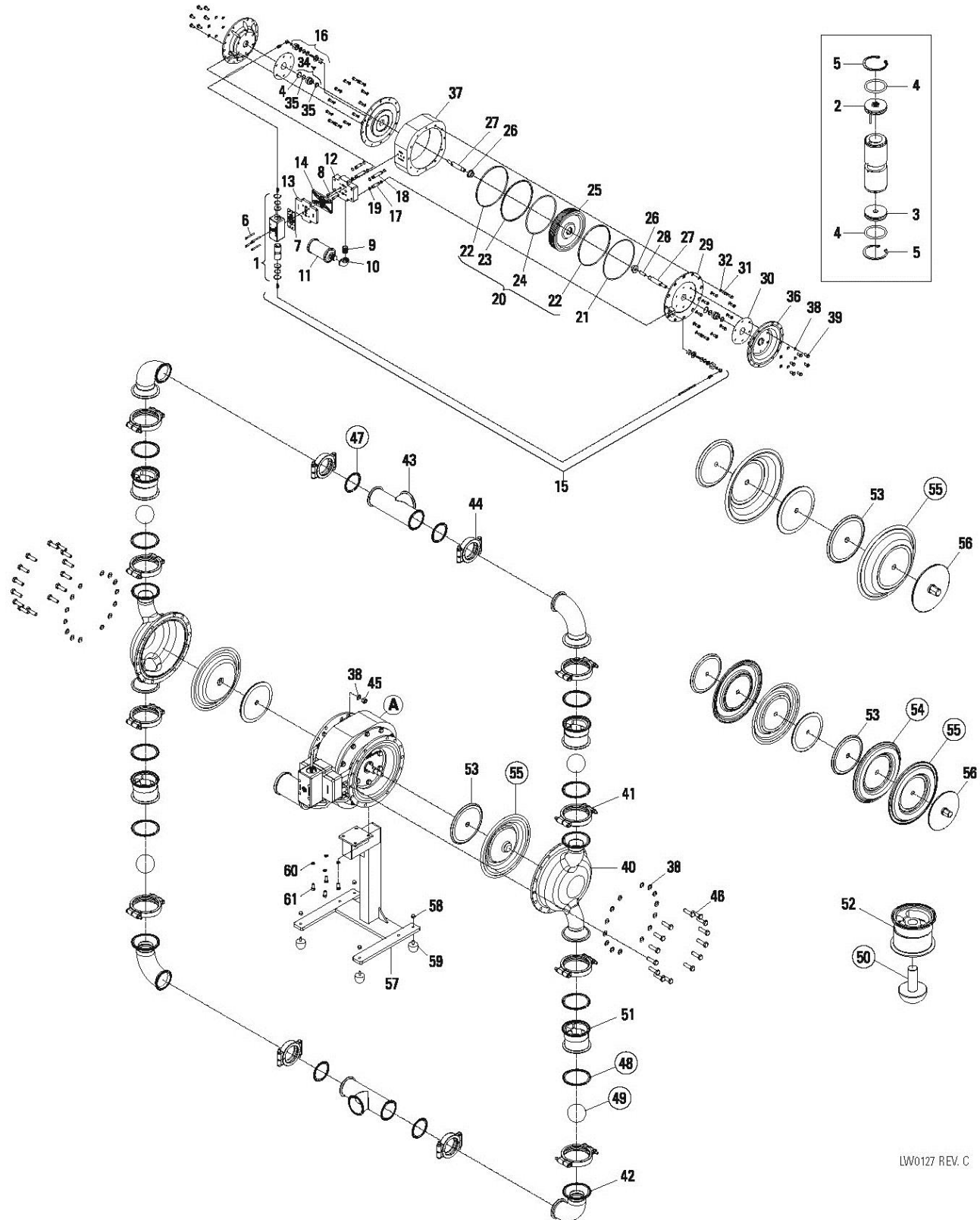

LW0127 REV. C

Exploded View and Parts List

Item	Part Description	Qty.	H1500/SZSII/... P/N	H1500/SSSII/... P/N
Air Distribution Components				
1	Air Valve Assembly¹	1	08-2003-45	08-2003-45
2	End Cap w/Guide Nylon	1	08-2306-23	08-2306-23
3	End Cap w/o Guide Nylon	1	08-2336-23	08-2336-23
4	O-Ring(-220)(Ø1.359xØ.139)	2	15-2390-52	15-2390-52
5	Retaining Ring	2	15-2650-03	15-2650-03
6	Screw, SHC, Air Valve (5/16"-18 x 2 3/4")	4	08-6000-03-83	08-6000-03-83
7	Air Valve Gasket	1	08-2601-52	08-2601-52
8	Screw, SHC, Manifold (3/8"-16 x 1 1/2")	2	99-6034-08	99-6034-08
9	Nipple, 1" NPT, Galvanized	1	08-7430-08-60	08-7430-08-60
10	Elbow, 90°, 1" NPT, Galvanized	1	08-7840-08-60	08-7840-08-60
11	Muffler	1	15-3510-99	15-3510-99
12	Manifold, Bottom Air Valve	1	08-2700-45	08-2700-45
13	Plate, Isolator Cover	1	08-2705-45	08-2705-45
14	Gasket, Air Valve Isolator	1	08-2603-52	08-2603-52
15	Relief Tube Assembly	2	08-9232-99-60	08-9232-99-60
16	Pressure Relief Valve Assembly	2	08-2742-99-60	08-2742-99-60
	Rebuild Pressure Relief Seal Kit	1	99-9346-99	99-9346-99
17	Pipe	2	08-7520-03-60	08-7520-03-60
18	Pipe	2	08-7510-03-60	08-7510-03-60
19	O-Ring (-114) Pipe (Ø.612 x Ø.103)	8	00-2870-52	00-2870-52
20	Power Piston Seal Kit ²	1	08-9210-99-60	08-9210-99-60
21	O-Ring (-379) Cover (Ø10.975 x Ø.210)	2	-	-
22	Guide Ring, Bronze-Filled	2	-	-
23	Slipper Seal, PTFE-Filled	1	-	-
24	O-Ring (-450) Piston (Ø10.475 x Ø.275)	1	-	-
25	Piston, Cylinder	1	08-3720-01-60	08-3720-01-60
26	Bushing, Cylinder Piston	2	08-3730-03-60	08-3730-03-60
27	Shaft	2	08-3800-03-60	08-3800-03-60
28	Stud, Shaft	1	08-6150-08-60	08-6150-08-60
29	Cover, Center Section	2	08-3000-45-60	08-3000-45-60
30	Gasket, Center Section	2	08-3260-52-60	08-3260-52-60
31	Screw, HHC (7/16"-14 x 1")	24	08-6260-08-60	08-6260-08-60
32	Washer (7/16")	24	08-6830-03-60	08-6830-03-60
33	Pipe Plug, 1/16" NPT	2	08-7030-08-60	08-7030-08-60
34	Bushing, Assembly Center Section ³	2	08-3300-99-60	08-3300-99-60
35	Glyd Ring	4	15-3210-55-225	15-3210-55-225
	O-Ring(-220)(Ø1.359xØ.139) Item No. 4	2	15-2390-52	15-2390-52
36	Chamber, Air	2	08-3653-03-60	08-3653-03-60
37	Section, Center	1	08-3158-45-60	08-3158-45-60
38	Washer (1/2")	12	08-6840-03-60	08-6840-03-60
39	Screw, HHC (1/2"-13 x 1")	12	08-6132-08	08-6132-08

Item	Part Description	Qty.	H1500/SZSII/... P/N	H1500/SSSII/... P/N
Wetted Path Components				
40	Chamber, Liquid CIP ³ EHEDG	2	15-5012-10-385P	15-5012-10-385P
41	Clamp Band Assy, 4"	8	15-7203-03	15-7203-03
42	Elbow, 3" EHEDG	4	15-5240-10-385P	15-5240-10-385P
43	T-Section, 3" EHEDG	2	15-5190-10-385P	15-5190-10-385P
44	Clamp Band, Assy, 3"	4	15-7103-03	15-7103-03
45	Hex Nut, (1/2"-13)	28	15-6420-03	15-6420-03
46	Screw, HHC (1/2"-13 x 1 3/4")	28	08-6190-08-60	08-6190-08-60
38	Washer (1/2")	56	08-6840-03-60	08-6840-03-60
Gaskets / Valve Balls / Mushroom Valve				
47	Gasket, 3", PKG 4	1	*	*
48	Gasket, 4", PKG 2	4	*	*
49	Valve Ball, PKG 4	1	*	*
50	Mushroom Valve, PKG 4	1	15-1096-55E	15-1096-55E
Check Valve Components				
51	Ball Cage, 3" EHEDG	4	15-5350-10-385P	15-5350-10-385P
52	Mushroom Valve Housing	4	15-5431-10-385P	15-5431-10-385P
FSIPD Components				
53	Piston, Inner, (Non-PTFE)	2	08-3700-03	
55	Diaphragm, Full Stroke IPD, Primary, PKG 2	1	08-1031-57E	
TPE Components				
53	Piston, Inner, (Non-PTFE)	2		08-3700-03
55	Diaphragm, Primary, PKG 2	1		08-1011-57E
56	Piston, Outer, (Non-PTFE)	2		08-4550-10-385P
PTFE Components				
53	Piston, Inner, (Non-PTFE)	2		08-3700-03
54	Diaphragm, Full Stroke PTFE, Backup, PKG 2	1		08-1065-57E
55	Diaphragm, Full Stroke PTFE, Primary, PKG 2	1		08-1040-55E
56	Piston, Outer, (Non-PTFE)	2		08-4550-10-385P
Fixed Stand Components				
57	Stand, Pump, PV Assy. ⁴	1	15-7653-10-385	15-7653-10-385
58	Nut, Cap, 5/16"-18, Pump Stand	4	08-6600-03-72	08-6600-03-72
59	Pad, Pump Stand	4	08-7670-20	08-7670-20
60	Washer, Flat (Ø.390 X Ø.625 X .063)	4	02-6730-03	02-6730-03
61	Screw, HHC, 3/8"-16 X 7/8"	4	08-6140-03	08-6140-03

LW0126 REV. B

*See Elastomer Chart - Section 9

¹ Air Valve Assembly includes item numbers 2, 3, 4, and 5.

² Power Piston Seal Kit includes item numbers 21, 22, 23, and 24.

³ Bushing Assembly, Center Section, includes qty. 1 of item numbers 34 and 4.

⁴ Stand Assembly includes item numbers 58 and 59.

▲ Product Contact Components.

All boldface items are primary wear parts.



CSI

CONTACT CSI FOR MORE INFORMATION | CSIDESIGNS.COM | SALES@CSIDESIGNS.COM | 417.831.1411

Section 10

Elastomer Options

H1500 SANIFLO™ HS

Material	Diaphragms (Color Code)	Full-Stroke Diaphragms (Color Code)	Full-Stroke Backup Diaphragms (Color Code)	Full-Stroke IPD Diaphragms (Color Code)	Valve Ball (Color Code)	Gasket, 3" (Color Code)	Gasket, 4" (Color Code)
FDA EPDM						15-1375-74 (green dot)	15-1215-74 (green dot)
PTFE		08-1011-55 (white)			15-1086-55 (white)	15-1375-55 (white)	15-1215-55 (white)
FDA Wil-Flex™	08-1011-57 (2 orange dots)		08-1067-57 (2 orange dots)	08-1032-57 (2 orange dots)	15-1086-57 (2 orange dots)		
FDA FKM						15-1375-68 (white/yellow)	15-1215-68 (white/yellow)

LW0167 REV. B

H1500 SANIFLO™ HS 1935/2004/EC

Material	Diaphragms (Color Code)	Full-Stroke Backup Diaphragms (Color Code)	Valve Ball (Color Code)	Gasket, 3" (Color Code)	Gasket, 4" (Color Code)
FDA EPDM				15-1375-74E (green dot)	15-1215-74E (green dot)
FULL-STROKE PTFE	08-1011-55E (white)		15-1086-55E (white)	15-1375-55E (white)	15-1215-55E (white)
FDA Wil-Flex™	08-1011-57E (2 orange dots)	08-1067-57E (2 orange dots)	15-1086-57E (2 orange dots)		
FDA FKM				15-1375-68E (white/yellow)	15-1215-68E (white/yellow)

LW0126 REV. B



WILDEN®

DECLARATION OF CONFORMITY



PSG California LLC, 22069 Van Buren Street, Grand Terrace, CA 92313-5607 USA, certifies as the manufacturer that the Air-Operated Double Diaphragm pumps listed below comply with the following European Community Regulations:

(EC) 1935/2004 for Food Contact Materials
(EC) 2023/2006 Good Manufacturing Practice

(EU) 10/2011 on plastic materials and articles intended to come in contact with food

- **25 mm (1") Saniflo Hygienic™ HS Metal Pump:**
(XPS,PS)2/(SS,SZ)(SSS,NNN)/(FBS,FES,FSL,FSS,LEL,TEU,TSS,TSU)/(FB,FE,FS,TF)/(FB,FE,FV,TF)/(0770-0789)E
- **38 mm – 76 mm (1-½"–3") Pro-Flo X Saniflo Hygienic™ HS Metal Pump:**
(PX,XPX)(4,8,15)/(SS,SZ)(SSS,NNN)/(BNU,EPU,FBS,FES,FSL,FSS,LEL,TEU,TSS,TSU,ZSS)/(FB,FE,FS,FV,SF,TF,TM)/(FB,FE,TF)/(0770-0789)E
- **38 mm – 76 mm (1-½"–3") Pro-Flo Shift Saniflo Hygienic™ HS Metal Pump:**
(PS,XP)S(4,8,15)/(SS,SZ)(SSS,NNN)/(FBS,FES,FSL,FSS,LEL,TSS,ZSS)/(FB,FE,FS,FV,SF,TF,TM)/(FB,FE,TF)/(0770-0789)E
- **76 mm (3") Saniflo HS High Pressure Advanced Metal Pump**
H1500/(SS,SZ)11/(FSL,TSS)/(TF,TM)/(FE,FV,TF)0770E
- **13 mm (½") Pro-Flo & Pro-Flo X™ Saniflo FDA Metal Pump Models:**
(P,PX,XPX)1/(SS,SZ)(AAA,GGG,JJJ,LLL,PPP)/(FSL,FSS,TEU,TSU)/(FS,TF)/(FS,TF)/(0067,0070,0120)E
- **25 mm (1") Pro-Flo Saniflo FDA Metal Pump Models:**
P2/(SS,SZ)111,PPP/(FBS,FES,FSL,FSS,LEL,TEU,TSS,TSU)/(FS,TF)/(FS,TF)/2070E
- **38 mm (1-½") Pro-Flo & Pro-Flo X™ Saniflo FDA Metal Pump Models:**
(P,PX,XPX)4/(SS,SZ)(AAA,LLL,NNN,SSS)/(BNU,EPU,FBS,FES,FSL,FSS,TEU,TSS,TSU)/(FS,TF)/(FS,STF)/(0067,0070,0075,0120)E
- **51 mm (2") Pro-Flo & Pro-Flo X™ Saniflo FDA Metal Pump Models:**
(P,PX,XPX)8/(SS,SZ)(AAA,PPP,NNN,SSS)/(BNU,EPU,FBS,FES,FSS,TEU,TSU,TSS)/(FS,TF)/(FS,STF)/(0070,0075,0120)E
- **76 mm 3" Pro-Flo X™ Saniflo FDA Metal Pump Models:**
(PX,XPX)15/(SS,SZ)(AAA,NNN,SSS)/(BNU,EPU,FSL,FSS,TEU,TSU,TSS)/(FS,TF)/(FS,STF)/(0070,0075,0120)E
- **38 mm 1-½" Pro-Flo Shift™ Saniflo FDA Metal Pump Models:**
XPS4/(SS,SZ)(AAA,NNN,SSS)/(FBS,FES,FSL,FSS,TSS,ZSS)/(FS,TF)/(FS,STF)/(0067,0070,0775,0120)E
- **51 mm 2" Pro-Flo Shift™ Saniflo FDA Metal Pump Models:**
XPS8/(SS,SZ)(AAA,NNN,SSS)/(FBS,FES,FSL,FSS,TSS,ZSS)/(FS,TF)/(FS,STF)/(0070,0075,0120)E
- **76 mm 3" Pro-Flo Shift™ Saniflo FDA Metal Pump Models:**
XPS15/(SS,SZ)(AAA,NNN,SSS)/(FSL,FSS,TSS,ZSS)/(FS,TF)/(FS,STF)/(0070,0120,0341)

Materials used in equipment that are intended to contact food belong to the groups of materials listed in Annex 1 (EC) 1935/2004 (List of groups of materials and articles which may be covered by specific measures)

5) Rubbers 8) Metal and Alloy 10) Plastics

Compliance is subject to material and equipment storage, handling and usage recommended by Wilden in the engineering operation and maintenance manual and supplemental technical publications.

This declaration is based on the following information:

- Statements of raw material from suppliers
- Total Migration Analysis per (EU) 10/2011

Wilden will make available to the competent authorities appropriate documentation to demonstrate compliance

Approved By:

Chris Distaso
Director of Engineering
Date: October 10, 2019



PSG
22069 Van Buren Street
Grand Terrace, CA 92313-5651 USA
P: +1 (909) 422-1730 • F: +1 (909) 783-3440
psgdover.com



Where Innovation Flows

PSG® reserves the right to modify the information and illustrations contained in this document without prior notice. This is a non-contractual document. 05-2018



CSI

CONTACT CSI FOR MORE INFORMATION | CSIDESIGNS.COM | SALES@CSIDESIGNS.COM | 417.831.1411